

EOSafe L/D

Safety Electronics System for Sauna Cabins



Installation and Operating Instructions

Made in Germany



Druck-Nr.: 2902 5044
Stand: 06/22

Documentation

Manufacturer

EOS Saunatechnik GmbH	
Schneiderstriesch 1	
35759 Driedorf, Germany	
Tel.	+49 2775 82-0
Fax	+49 2775 82-431
Mail	servicecenter@eos-sauna.com
Web	www.eos-sauna.com

Original installation instructions EN







Copyright for these installation instructions remains with EOS Saunatechnik GmbH.

Copyright as per DIN ISO 16016:

The copying and distribution of this document, as well as the use and communication of its contents without express authorisation, are not permitted. Compensation will be claimed in the event of infringements.

All rights reserved with regard to patent claims or submission of design or utility patent.

Characters, symbols and illustrations

-  Additional information about an operating step
-  Cross-reference to a page
-  Read instructions
-  Result of a step
-  Table title
-  Title of figure

Revision history

Date	Version	Description
21.01.2022	02.00	Cover page: UKCA mark and VDE mark added, general safety instructions updated, text content for cable lengths updated.
07.01.2020	01.10	New nameplate
12 June 2019	01.00	First version

Contents

Documentation	EN-2
1 General safety instructions	EN-5
1.1 Mounting and electrical installation	EN-5
1.2 Operator instruction	EN-6
1.3 Safety levels.....	EN-8
1.4 Standards and regulations.....	EN-8
2 Identification	EN-9
2.1 Information about the unit.....	EN-9
2.1.1 EOSafe L/D supervision unit.....	EN-9
2.1.2 EOSafe L.....	EN-10
2.1.3 EOSafe D.....	EN-12
2.1.4 Control panels.....	EN-13
2.2 Intended use	EN-13
3 Description of the units	EN-14
3.1 EOSafe L/D supervision unit housing	EN-16
3.2 Installation overview.....	EN-17
3.3 Circuit board	EN-19
3.4 EOSafe L.....	EN-20
3.5 EOSafe D.....	EN-22
4 Mounting	EN-25
4.1 Mounting the supervision unit housing	EN-25
4.1.1 Mounting location	EN-25
4.1.2 Mounting the EOSafe L/D supervision unit housing	EN-28
4.2 Mounting the light barrier and reflectors	EN-30
4.2.1 Mounting location	EN-30
4.2.2 Mounting the reflector	EN-31
4.2.3 Mounting the light barrier	EN-31
4.3 Mounting the door supervision device and magnet	EN-36
4.3.1 Mounting location	EN-36
4.3.2 Mounting the door supervision device	EN-36
4.3.3 Aligning the magnet and mounting the magnet housing	EN-38

5	Installation	EN-41
5.1	Routing cables in the EOSafe L/D supervision unit	EN-41
5.2	Connecting the safety circuit to EOSafe L/D	EN-45
5.3	Connecting the lines for start-up status	EN-47
5.4	Connecting the sauna bus cable (optional for EmoTec, EmoStyle, EmoTouch 3)	EN-52
5.5	Connecting the light barrier	EN-55
5.6	Connecting the door supervision device	EN-57
6	Commissioning	EN-59
6.1	Configuring addresses for multi-cabin installations (optional)	EN-60
6.2	Commissioning with EmoTouch 3	EN-62
6.2.1	Teaching in the light barriers	EN-62
6.2.2	Deleting light barriers	EN-64
6.2.3	Teaching in the door supervision device	EN-65
6.2.4	Deleting RFID tags	EN-69
6.3	Commissioning with EmoTec, EmoStyle, and Econ.....	EN-70
6.3.1	Teaching in the light barriers	EN-70
6.3.2	Deleting light barriers	EN-72
6.3.3	Teaching in the door supervision device	EN-73
6.3.4	Deleting an RFID tag	EN-77
6.4	Confirming with RFID tags that the cabin is safety compliant	EN-78
6.5	Commissioning checks	EN-79
6.5.1	Safety circuit – EOSafe L/D, EOSafe L, EOSafe D.....	EN-79
6.5.2	3-phase installation – EOSafe L/D, EOSafe L.....	EN-82
6.5.3	Signal S1/S2 (start-up status) – EOSafe L/D, EOSafe L, EOSafe D	EN-84
6.5.4	Door supervision device – EOSafe L/D, EOSafe D.....	EN-87
6.5.5	Light barrier – EOSafe L/D, EOSafe L	EN-88
6.5.6	Confirming the installation check	EN-89
7	Cleaning and troubleshooting	EN-90
7.1	Checking and possibly cleaning all light barrier front panels and reflectors.....	EN-90
7.2	Readjusting the light barriers	EN-91
7.3	Flashing codes.....	EN-91
7.4	Troubleshooting	EN-93
8	General terms and conditions of service	EN-94
9	Disposal	EN-97
10	Declaration of conformity	EN-98

1

General safety instructions

1.1 Mounting and electrical installation



These installation instructions are intended for qualified personnel familiar with the laws and regulations applicable to electrical installations at the installation site. Observe the following general safety instructions during mounting, configuration and commissioning of the product.

Risk to life and limb and risk of fire

Risk to life and limb from electric shock and fire in the event of improper or faulty electrical connection. This risk also applies following completion of the installation work.

- ▶ The electrical installation of EOSafe L/D, the relay box and other electrical systems or equipment with a fixed mains connection must only be performed by a trained electrician from an authorised electrical company.
- ▶ Observe the stipulations in VDE 0100 part 701.
- ▶ The system must be disconnected and removed entirely from the mains supply before commencing installation and repair work.
- ▶ The housing cover must only be removed by a specialist.
- ▶ Do not install EOSafe L/D, control panels, relay boxes and supervision units in enclosed cabinets or wood panelling.

General safety instructions

1.2 Operator instruction

The operator of the sauna cabin must be instructed in the general safety instructions during commissioning. The operator must be given a copy of the instructions for use.

- Risk of electric shock** A risk to life and limb from electric shock and fire arises in the event of improper repair work. This risk also applies after work is completed.
- ▶ The housing cover must only be removed by a specialist.
 - ▶ Repairs and installations must only be performed by a trained specialist.
 - ▶ The system must be disconnected and removed entirely from the mains supply before commencing repair work.
 - ▶ Use only original spare parts from the manufacturer.
- Fire hazard** Objects placed on the sauna heater can easily be ignited and cause fires.
- ▶ Do not place objects on the sauna heater.
- Health risks** Spending time in a sauna cabin can lead to serious health risks or even death for persons with health impairments.
- ▶ Persons with health impairments who spend time in a sauna must consult a doctor before entering a sauna cabin.
- Equipment damage due to overuse** Excessive humidity in commercial sauna cabins can lead to property damage.
- ▶ In a commercial sauna cabin, the heating time must be set so that the heater switches off automatically after a specific period of time.
 - ▶ If the heating does not switch off automatically after a defined heating period, cabin use must be supervised at all times.
 - ▶ Inspect the cabin before each use.
- Damage to the equipment due to fluctuations in temperature** The glass reflectors of the EOSafe L can shatter if temperatures fluctuate quickly.
- ▶ Do not pour infusion liquid on the reflectors.

**Operation by
children or persons
with reduced mental
capacity**

Children and persons with reduced mental capacity can be a risk.

- ▶ Children must be supervised to ensure they do not play with the unit.
- ▶ Children under 8 should not operate the sauna cabin.
- ▶ The settings for the heating time must only be used by children under 8 years of age if they are supervised by an adult.
- ▶ The sauna cabin must only be used by persons with reduced mental capacity, or limited physical or sensory abilities under supervision or if they have already been instructed in its use and understand the risks.
- ▶ Children and persons who have not received proper instruction must not clean or service the system.

General safety instructions

1.3 Safety levels

Safety instructions and important operating instructions are classified according to ANSI Z535.6. Please familiarise yourself with the following terms and symbols:

WARNING

Warning

Indicates a hazardous situation which, if not avoided, could result in death or serious injury.

CAUTION

Caution

Indicates a hazardous situation which, if not avoided, could result in minor or moderate injury.

NOTICE

Notice

Indicates a hazardous situation which, if not avoided, will result in damage to the unit.

1.4 Standards and regulations

For an overview of the standards that were observed during design and construction of the sauna heaters, please refer to the individual product's technical data sheet that can be downloaded from www.eos-sauna.com.

2

Identification

EOSafe is available in versions EOSafe L and EOSafe D, and in the combination EOSafe L/D.

- EOSafe L supervises a sauna heater with up to four light barriers. Before EOSafe L is switched on, it checks to ensure that the reflectors on the heater are unobstructed. For example, it detects if a towel was accidentally placed on the heater.
- EOSafe D supervises the door and checks whether the door has been opened since the last inspection round.

2.1 Information about the unit

2.1.1 EOSafe L/D supervision unit



- | | |
|----------------------------|-----------------------------|
| A Name | E Manufacturer |
| B Model | F Protection class |
| C Item number | G Manufacturing date |
| D Country of origin | H Serial number |

 EOSafe L/D nameplate

Requirements for operation and storage – EOSafe L/D

The following climate condition requirements must be met for the supervision unit at the installation location:

- Ambient temperature during operation: -10°C to 40°C
- Storage temperature: -20°C to 60°C

Identification

2.1.2 EOSafe L

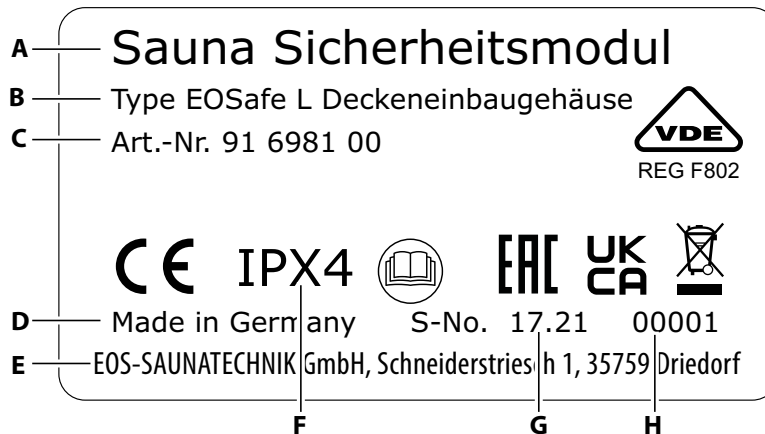

- | | |
|---|-----------------------------|
| A Name | F Manufacturer |
| B Model | G Protection class |
| C Item number | H Manufacturing date |
| D Temperature limit for glass/connection | I Serial number |
| E Country of origin | |
- Nameplate for EOSafe L flush-mounting ceiling unit

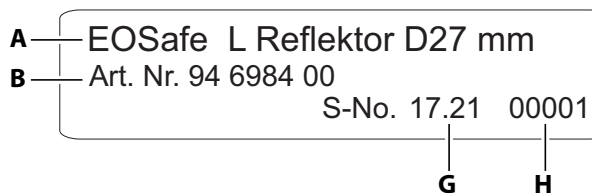
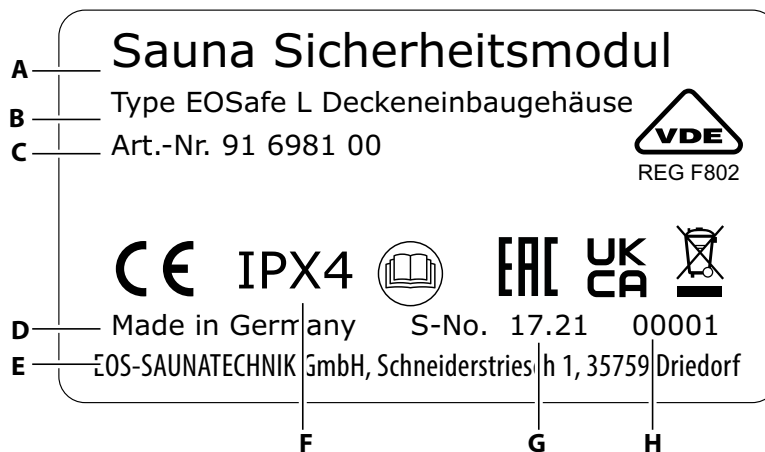

- | | |
|----------------------------|-----------------------------|
| A Name | E Manufacturer |
| B Model | F Protection class |
| C Item number | G Manufacturing date |
| D Country of origin | H Serial number |
- Nameplate for EOSafe L reflector D 27 mm

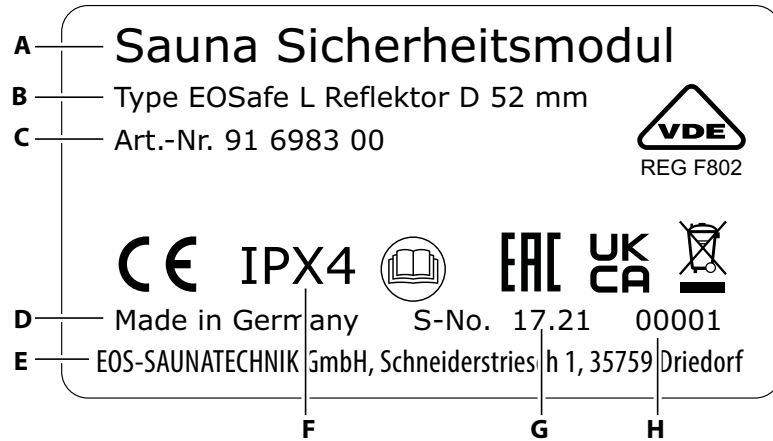

- | | |
|----------------------------|-----------------------------|
| A Name | E Manufacturer |
| B Model | F Protection class |
| C Item number | G Manufacturing date |
| D Country of origin | H Serial number |

 Nameplate for EOSafe L reflector D 52 mm

Requirements for operation and storage – EOSafe L

The light barrier and reflectors should be mounted inside the sauna cabin. The door supervision device and the supervision unit with supervision electronics should be mounted outside of the sauna cabin. The following climate condition requirements must be met for the light barriers at the mounting location:

- Ambient temperature during operation, front light barrier: -10°C to 140°C
- Storage temperature: -20°C to 60°C

Identification

2.1.3 EOSafe D

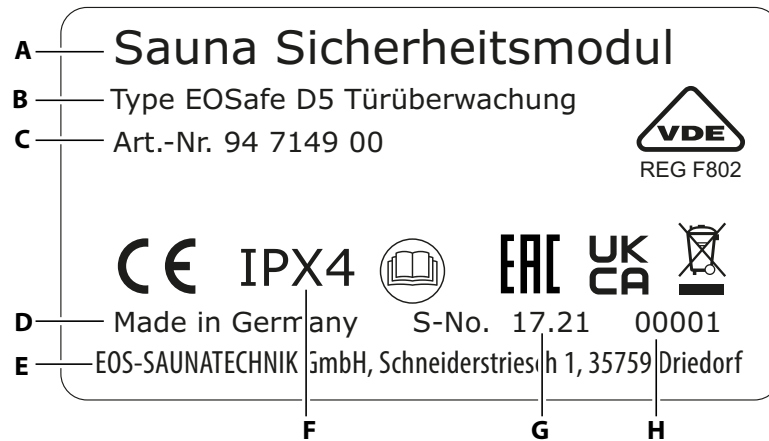

- | | |
|----------------------------|-----------------------------|
| A Name | E Manufacturer |
| B Model | F Protection class |
| C Item number | G Manufacturing date |
| D Country of origin | H Serial number |
-  Nameplate for EOSafe D5 door supervision device

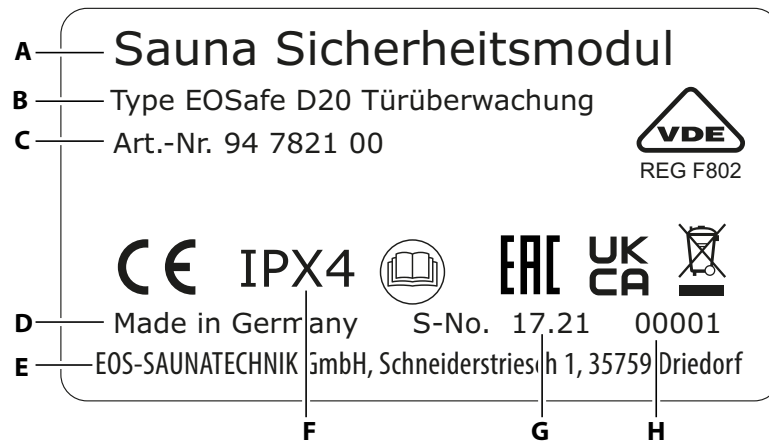

- | | |
|----------------------------|-----------------------------|
| A Name | E Manufacturer |
| B Model | F Protection class |
| C Item number | G Manufacturing date |
| D Country of origin | H Serial number |
-  Typenschild EOSafe D20 Türüberwachung

Requirements for operation and storage – EOSafe D

EOSafe D should be mounted outside the sauna cabin. The mounting location must meet the following climate condition requirements:

- Ambient temperature during operation: -10°C to 65°C
- Storage temperature: -20°C to 60°C

2.1.4 Control panels

The safety devices can be used with the following control panels:

- EmoStyle
- EmoTec
- EmoTouch 3
- Econ D1-D4/H1-H4

2.2 Intended use

EOSafe L/D is used as a stand-alone safety device for sauna cabins. EOSafe consists of EOSafe L and EOSafe D, which can be used individually or together.

- EOSafe L ensures intrinsic safety in accordance with EN 60335-2-53, section 19.101.
- EOSafe D operates the remote control interlocking in accordance with EN 60335-2-53, section 22.108.

EOSafe L/D is not suitable for outdoor use.



It must be operated only inside buildings and may not be exposed to environmental conditions such as extreme humidity and moisture or the possible formation of condensation or corrosive substances in the ambient air, as well as other weather conditions. Similarly, excessive cold and extreme exposure to sunlight must be prevented. Protect the unit accordingly if there is an increased risk of mechanical damage.

Foreseeable misuse

The following are considered instances of foreseeable misuse:

- The unit is operated after technical or other modifications are made to the supervision unit.
- The unit is operated by children or persons with reduced mental capacity or by persons who have not been thoroughly instructed in its use.

Description of the units

3

Description of the units

EOSafe L/D is used to ensure that the sauna is safety compliant so it can be switched on via the remote control.

EOSafe L/D can be set up on the supervision unit or at the EmoTouch 3 control panel.

The EOSafe L/D supervision unit is enclosed in a plastic housing. The housing completely encloses the circuit board and the electronics.

Scope of delivery for the EOSafe L/D supervision unit

- Supervision unit with pre-attached mains connecting cable and cable clips in the housing, length: 1.5 m
- Connecting cable 3 x 1.5 to the relay box of the sauna control unit, length: 5 m/20 m
- S-Bus connecting cable to the control panel, length: 5 m
- 1 silicone line 2 x 0.5 to connect EOSafe L/D to the safety temperature limiter circuit of the relay box, length: 5 m
- 3 screws to mount supervision unit to the wall
- 4 cable bushings

EOSafe L scope of delivery

In addition to the supervision unit, the following components are included in the scope of delivery:

- 1 light barrier unit (up to 4 pcs. optional) with attached connecting cable, length: 5 m
- 3 wooden screws (per light barrier unit) for mounting on the ceiling
- 1 glass reflector (per light barrier unit) with bracket, diameter 27 or 52 mm, with retaining screws
- EOSafe L commissioning checklist

EOSafe D scope of delivery

In addition to the supervision unit, the following components are included in the scope of delivery:

- RFID in housing with pre-attached connecting cable with RJ plug, length: 5 m, adhesive strip on the back of the housing for mounting on door frame
- Housing with magnetic block, 4 fillers, adhesive strip for mounting on the door panel
- 2 RFID tags (up to 10 pcs. optional) as key chains
- EOSafe D commissioning checklist

Accessories (optional)

EOSafe L/D accessories	Item no.
10 m connecting cable for sauna bus (RJ12/RJ12)	94.5861
25 m connecting cable for sauna bus (RJ12/RJ12)	94.4647
50 m connecting cable for sauna bus (RJ12/RJ12)	94.4648
Modular distributor RJ for connecting cable for control panel and sauna bus	2001.5298

EOSafe L accessories	Item no.
Reflective light barrier for flush-mounting ceiling unit	94.6981
Reflector (diameter 52 mm) for reflective light barrier	94.6983
Reflector (diameter 27 mm) for reflective light barrier	94.6984

EOSafe D accessories	Item no.
EOSafe D5, Door supervision device with 5 m cable	94.6993
EOSafe D20, Door supervision device with 20m cable	94.7822
RFID tag transponder K4 (confirmation key)	4059.8600

Description of the units

3.1 EOSafe L/D supervision unit housing

The plastic housing completely encloses the circuit board.

Power is supplied via the mains supply; the mains cable is pre-attached.

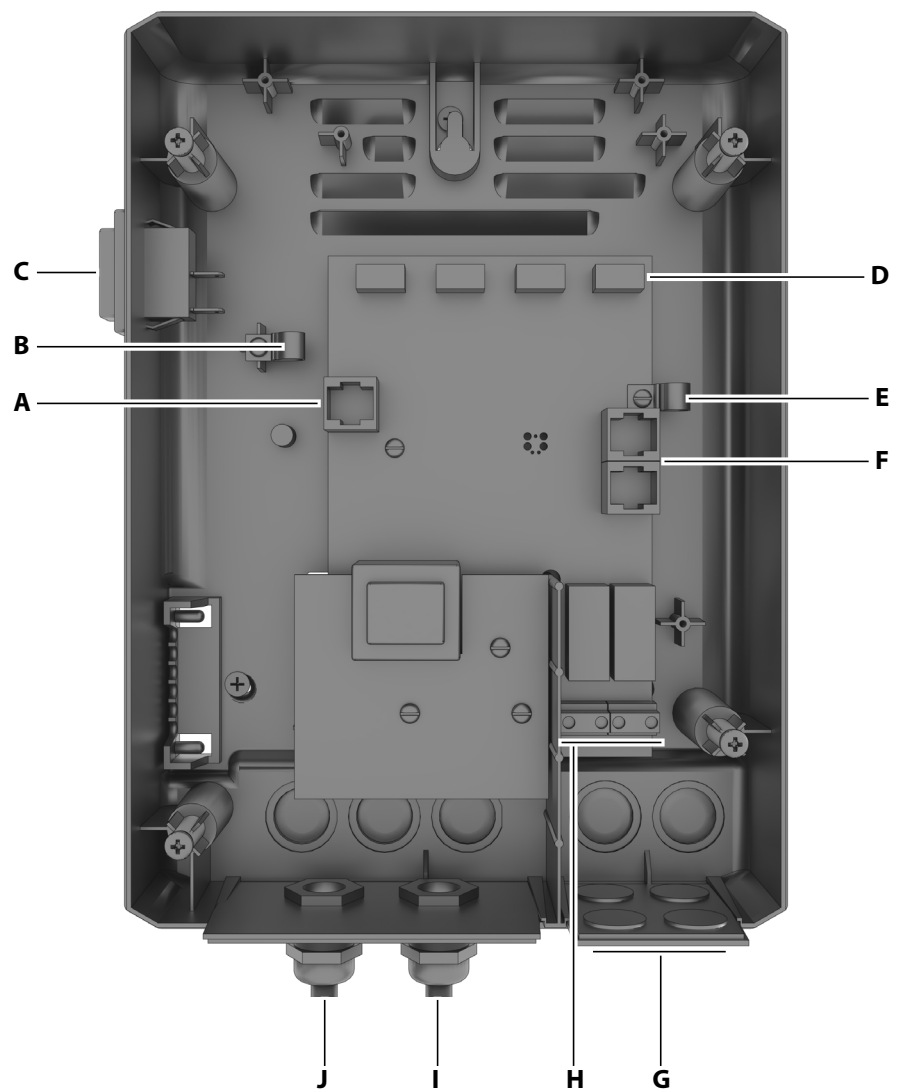

- | | |
|--|---|
| A Connection for door supervision device | G Cable feed opening for light barrier, door supervision device, bus lines |
| B Cable clip, line to switch | H Terminals for safety temperature limiter circuit |
| C On/off switch | I Cable screw connection for line to sauna relay box |
| D Light barrier connections 1 to 4 | J Cable screw connection, mains lead |
| E Cable clip, light barrier and bus lines | |
| F Sauna bus connection (S-Bus) | |
|  Bottom piece of EOSafe L/D housing | |

3.2 Installation overview

EOSafe L/D components

EOSafe L/D includes the following components as shown below.

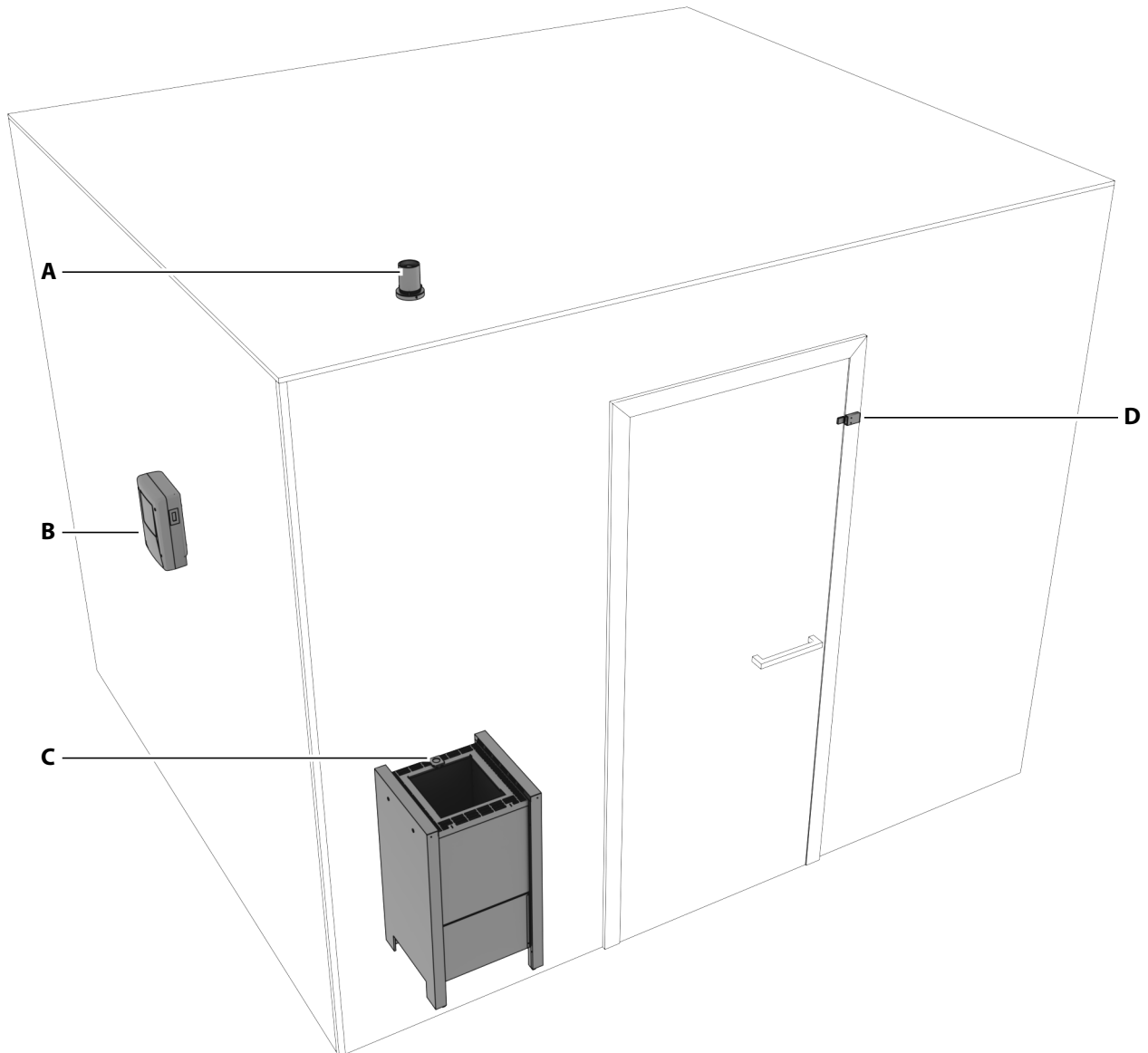

A EOSafe L light barrier
B EOSafe L/D supervision unit

C EOSafe L reflectors
D EOSafe D door supervision device (door sensor and magnet)

 EOSafe L/D components

The standard length of the cable from the door monitor (D) to the evaluation unit is 5 m. As an alternative an RFID element with 20 m connection cable is available, see Accessories (optional), [EN-15](#).

Description of the units

EOSafe L/D installation

EOSafe L should be installed as indicated below.

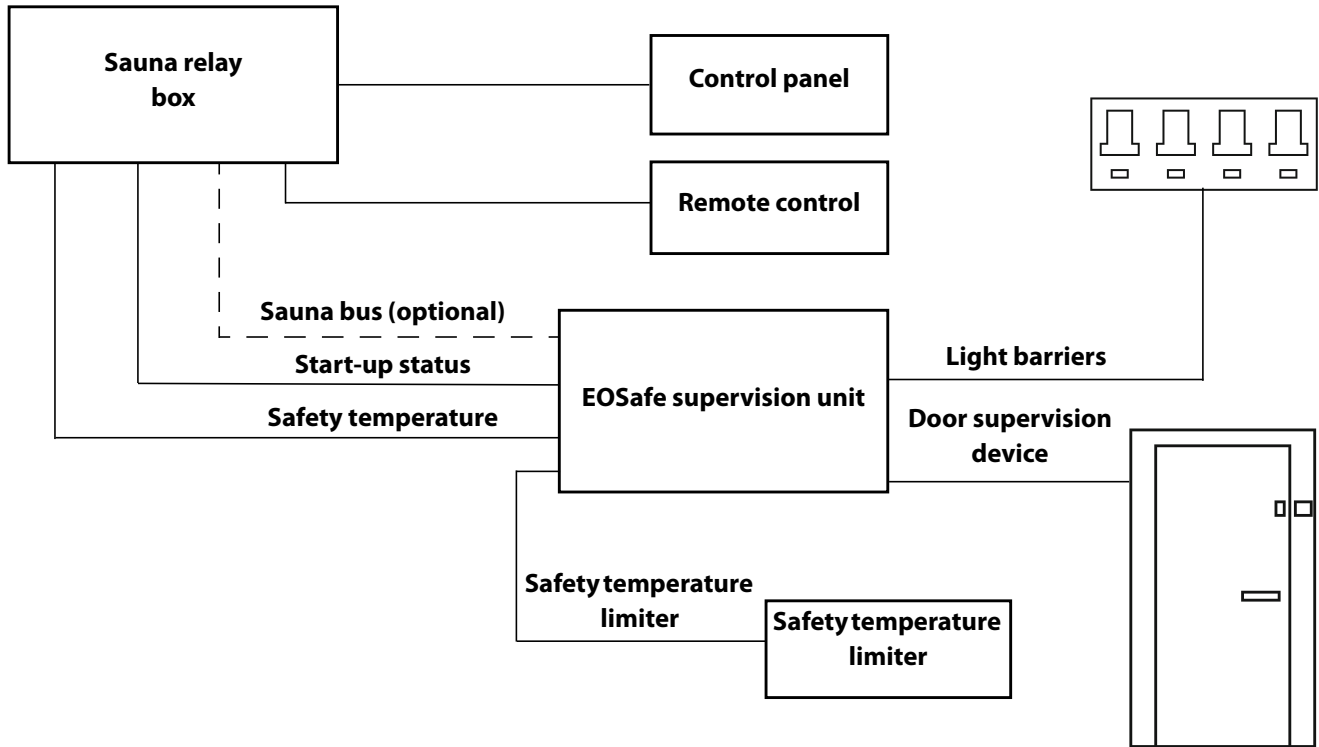

☒ EOSafe L/D installation

The standard length of the cable from the door monitor (D) to the evaluation unit is 5 m. As an alternative an RFID element with 20 m connection cable is available, see Accessories (optional), ☐ EN-15.

3.3 Circuit board

EOSafe L/D is installed with a supervision unit that is used for both EOSafe L and EOSafe D. All components are connected to this unit. The circuit board is located in the supervision unit housing.

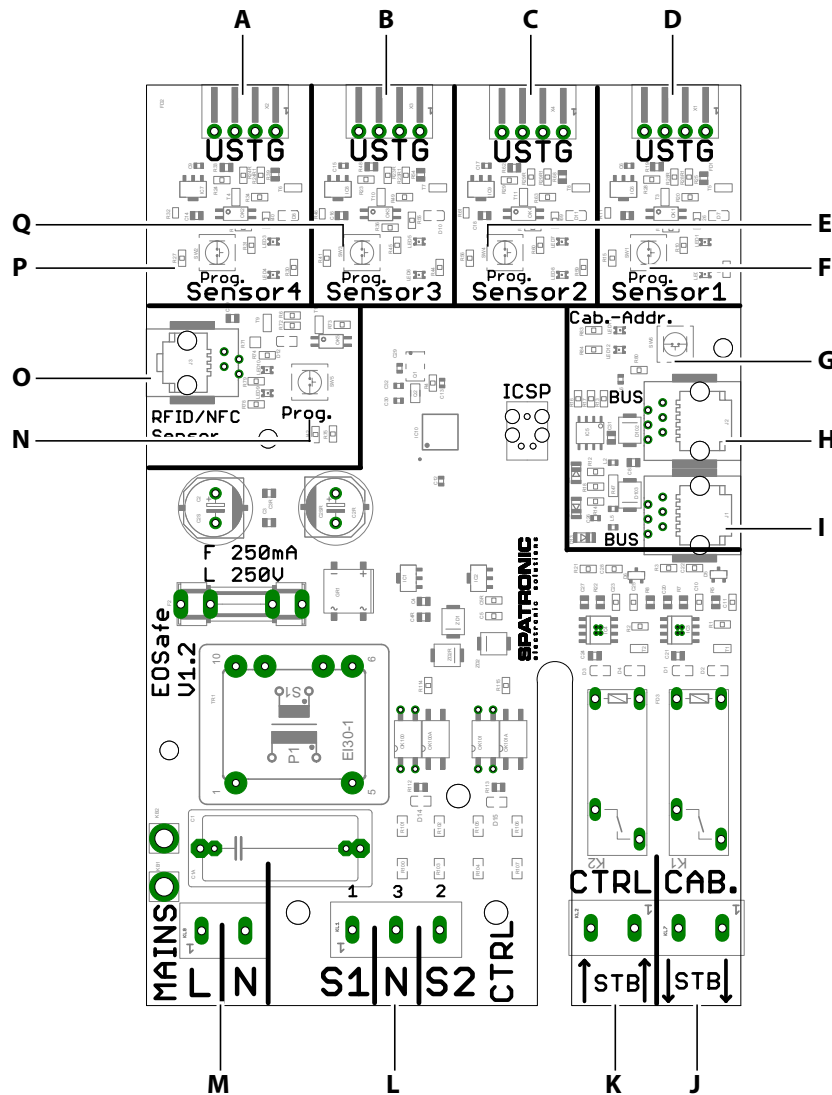

- | | |
|---|---|
| <ul style="list-style-type: none"> A Connection for light barrier 4 B Connection for light barrier 3 C Connection for light barrier 2 D Connection for light barrier 1 E Programming button for light barrier 2 F Programming button for light barrier 1 G Programming button for cabin address H Connection for sauna bus 1 I Connection for sauna bus 2 | <ul style="list-style-type: none"> J Safety circuit, output to safety temperature limiter K Safety circuit, input from relay box L Connection for start-up status from relay box (pre-attached) M Mains supply (pre-attached) N Programming button for door supervision device O Connection for door supervision device P Programming button for light barrier 4 Q Programming button for light barrier 3 |
|---|---|

EOSafe L/D circuit board connections

Description of the units

3.4 EOSafe L

EOSafe L uses light barriers that check for objects on the sauna heater when it is switched on.

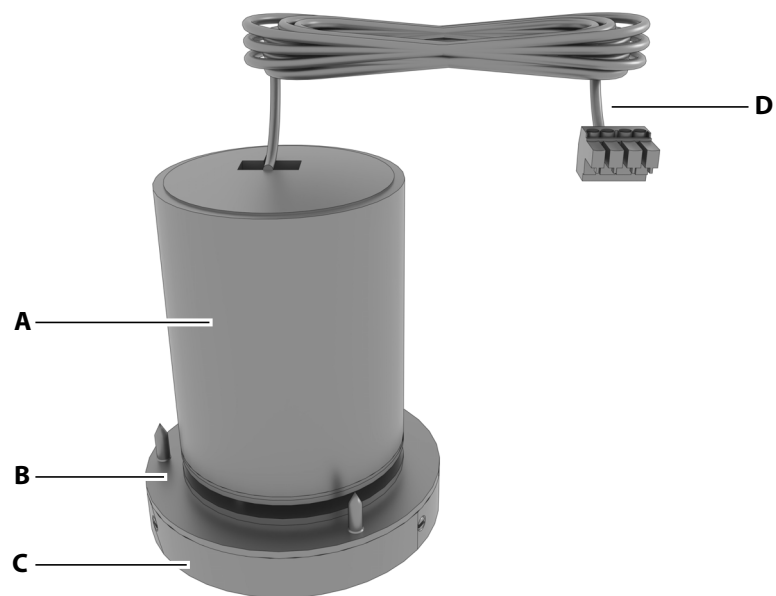

- A** Electronics
B Contact surface area on cabin
C Front
D Cable with pre-attached plug ceiling
- ☒ EOSafe L, light barrier and electronics

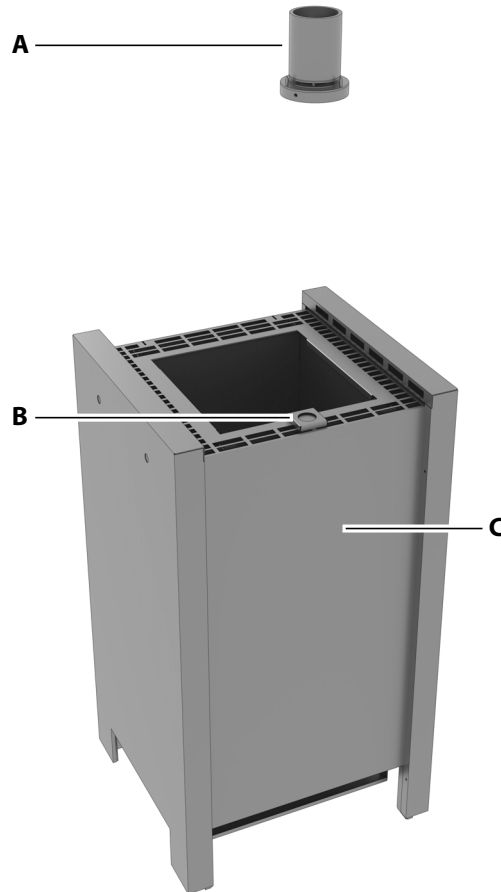

- A** Light barrier, sender/receiver **C** Heater
B Reflector

 EOSafe L – mounting diagram

EOSafe L can monitor up to 4 light barriers with reflectors. They can be used for one heater only or distributed across up to 4 heaters. All heaters must be located in one sauna cabin and be controlled by the same control unit.

Operating principle

The reflector is mounted on the sauna heater, with the light barrier's sender and receiver above it. If there is an object on the heater, for example, a towel, the light beam is interrupted which in turn interrupts the safety circuit. The heater cannot be switched on.

EOSafe L performs safety supervision only when the heater is switched on and during the heat-up phase. Safety supervision is not performed when the heater is off or hot.

All connected light barriers must be taught in. The safety circuit is interrupted if light barriers are connected but not taught in.

Description of the units

EmoTouch 3 can be used to teach in and operate the light barriers. Programming must be done directly at the supervision unit's circuit board for systems that use EmoTec, EmoStyle or Econ controls.

Reflectors

Light barrier reflectors are available in diameters of 27 mm and 52 mm. The maximum distance between sender/receiver and reflectors is 1.5 m for small reflectors and 2.25 m for large reflectors.

3.5 EOSafe D

EOSafe D is a door supervision device that uses RFID technology. This technology ensures that the sauna is safe and ready to be switched on.

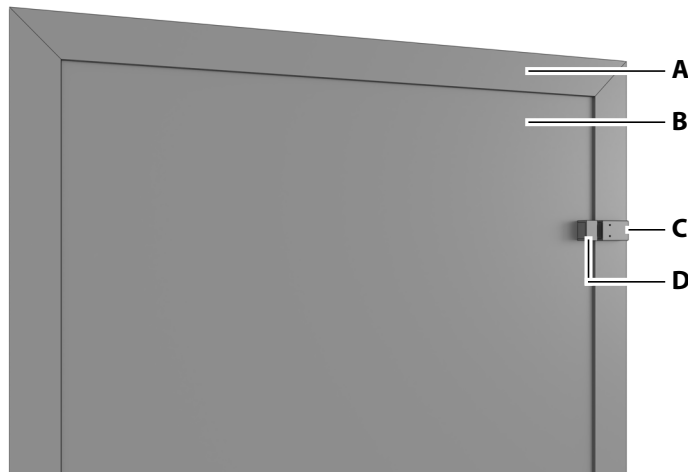

A Door frame
B Door panel

C Door supervision device with magnetic switch and RFID
D Magnet

 EOSafe D

Operating principle

After the cabin safety check is complete, personnel use RFID tags (maximum 10 pcs.) to confirm that the cabin is safe and ready to be switched on.

- If the door has not been opened since the safety check, the sauna can be started via remote control, at the preset time or manually.
- If the cabin has been opened after the safety check or within 10 minutes of being started up, heating is interrupted. In this case, the cabin must be checked again and approved by personnel.

Door supervision device

The door supervision device has a hall sensor for magnet door supervision and an RFID reader. It also comes with up to 10 RFID tags that can be issued to authorized personnel. The RFID reader is mounted on the sauna's door

frame and the magnet is attached to the door so that it is opposite the reader when the door is closed. This ensures that the reader is able to determine whether the door was opened after personnel used an RFID tag to confirm that the sauna cabin is safe and ready to be switched on.

Magnet, distances, positions

The figure below shows the door supervision device mounted on the door frame and the magnet mounted on the door panel.

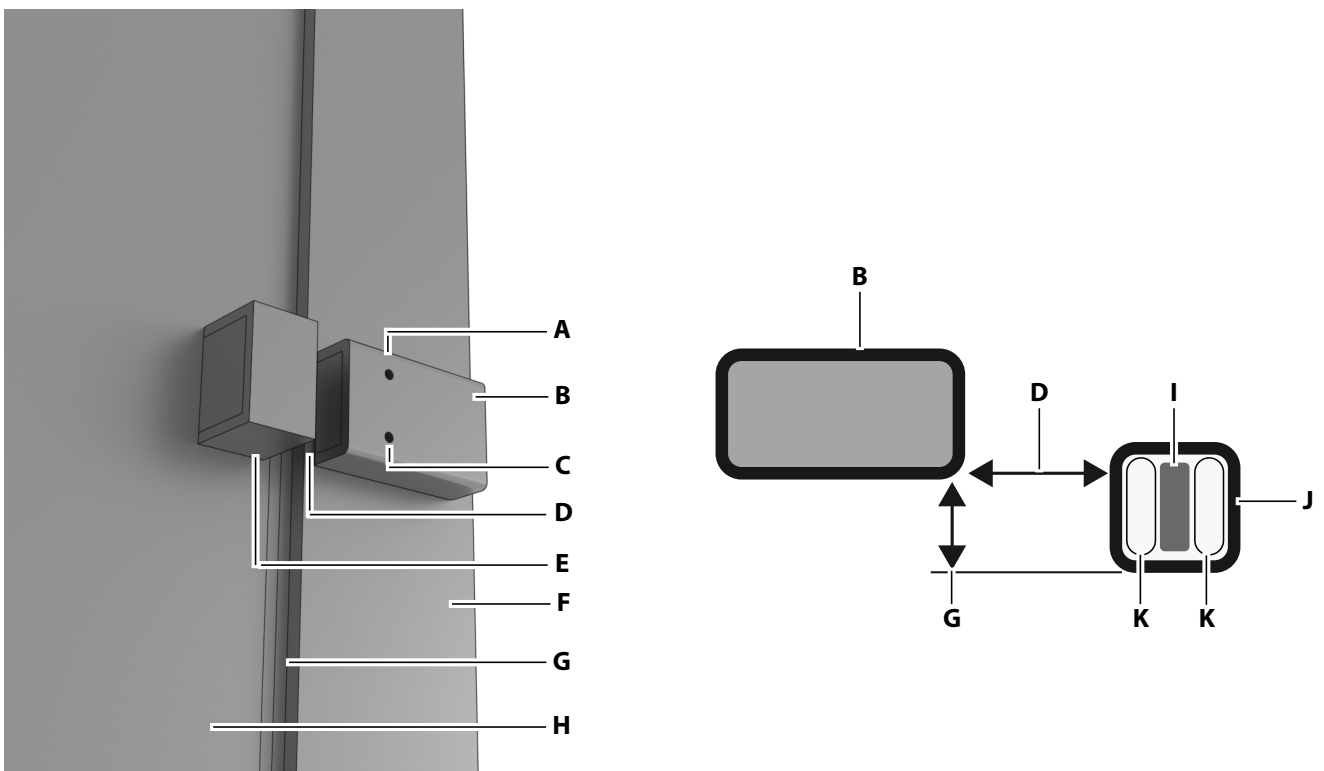



- A** Green LED
- B** Door supervision device
- C** Red LED
- D** Distance

- E** Magnet housing
- F** Door frame
- G** Offset
- H** Door panel

- I** Magnet
- J** Magnet housing
- K** Fillers

 Door supervision device and magnet mounted

The door supervision device and magnet can be mounted with various offsets and at various distances and the magnet can be mounted in various positions in the housing. See  Distances and offsets for magnet positioning,  EN-38.

Offset **G** can result from an offset between the door frame and door panel. Distance **D** can be a result of the condition of the door frame and door panel. Keep the offset and distance to a minimum when mounting the door supervision device to ensure that it works properly. Mill out the door frame or door panel as needed to ensure that the offset or distance is correct.

Description of the units

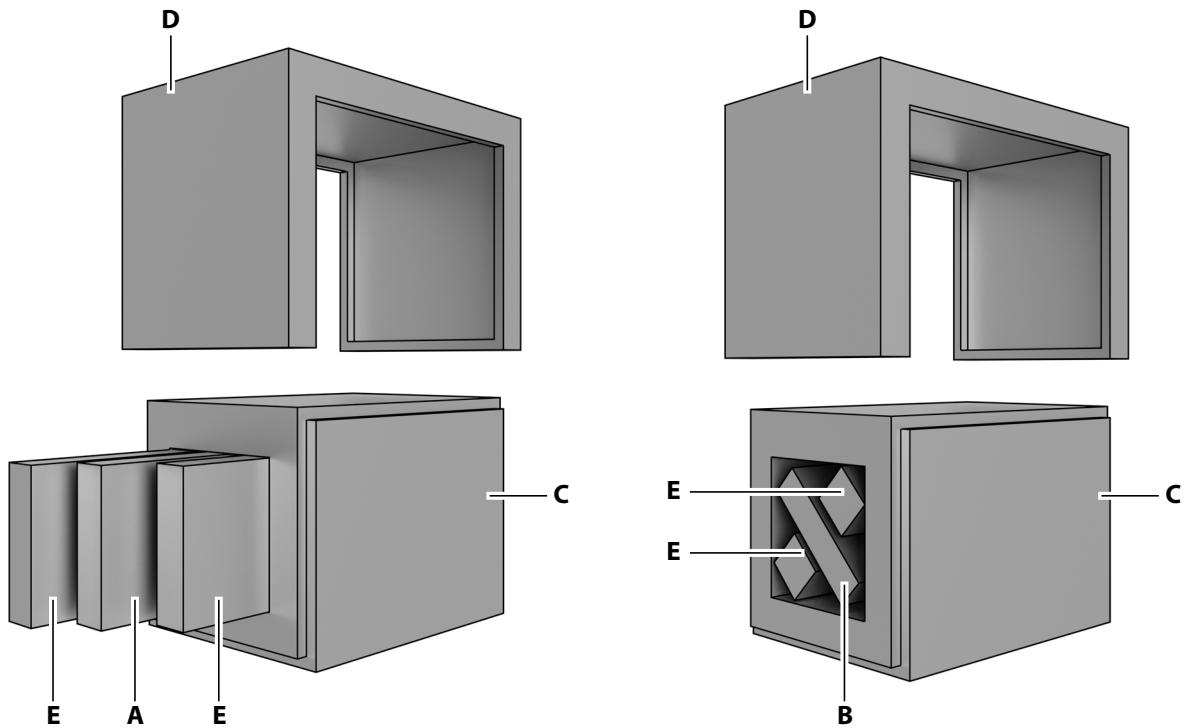

A Magnet in vertical position in the housing

B Magnet in diagonal position in the housing

C Magnet housing

D Cover

E Fillers

 Magnet in housing

You can position the magnet (**A**) in the magnet housing (**C**) in various positions using fillers (**E**).

4

Mounting

This chapter describes how to install the EOSafe L/D supervision unit and its individual components.

NOTICE

Equipment damage

Corrosive environments or environments with high levels of saline in the air could damage lines and circuit boards.

- ▶ Use EOSafe L/D only in an environment with no corrosive substances.

4.1 Mounting the supervision unit housing

The EOSafe L/D supervision unit is mounted on the outer wall of the cabin or in the utility room. First install the supervision unit before you install the light barriers and door supervision device.

4.1.1 Mounting location

All lines should be routed before mounting the supervision unit. Connections can be established later. The cables must be routed and connected in such a way that they are not openly accessible.

⚠ WARNING

Risk to life and limb and risk of fire

Risk to life and limb from electric shock and fire in the event of improper or faulty electrical connection. This risk also applies following completion of the installation work.

- ▶ Do not install EOSafe L/D supervision units in enclosed cabinets or wood panelling.

Mounting

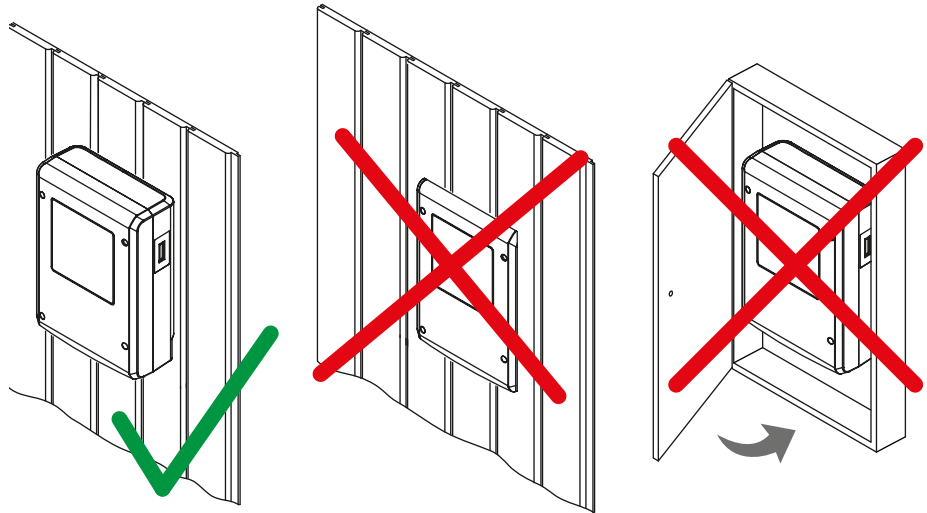

☒ Proper and improper mounting of the EOSafe L/D supervision unit

- Cable length for mains connection: 1.5 m.
- For mounting use a stable wall that can bear the weight of the supervision unit.
- Cable length of EOSafe supervision unit to light barriers and door supervision device unit: 5 m.
- Cable length of S-Bus lines between sauna relay box and supervision unit: 10 m.
- All pipelines and connections must be accessible for service.

NOTICE

Electronics malfunctions

Routing data and power supply lines together can lead to electronics malfunctions because, e.g. because the sensor will not be detected.

- ▶ Do not route sensor and sauna bus lines together with power supply lines.
- ▶ Route cable conduits separately.

Line routing

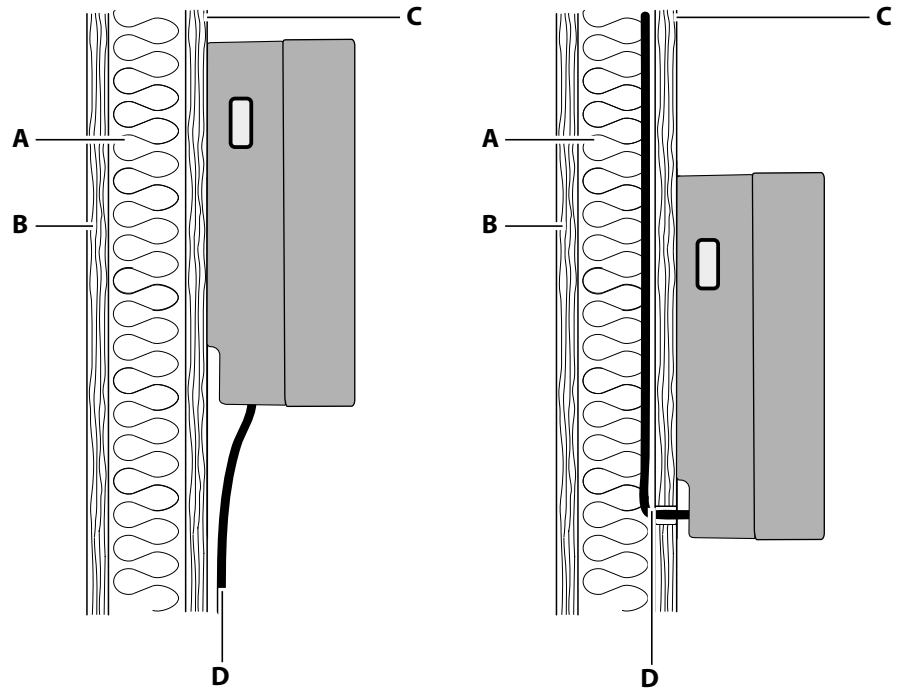

- | | |
|----------------------------------|----------------------------------|
| A Insulation | C Outer wall of the cabin |
| B Inner wall of the cabin | D Connecting lines |

 Diagram – routing of data and control line(s)

The mains, S-Bus, sensor and start-up status cables can be routed to the relay box as follows:

- The cables can be routed along the outer wall of the cabin. They are then passed into the housing from below. If they are not routed through a cable conduit or a duct, they must be secured so they cannot be pulled out.
- The cables can be routed between the insulation and the outer wall of the cabin. They are then passed into the housing from the rear.

In both cases, the cabin insulation must be installed in such a way that the temperature in the area in which cables are routed cannot exceed 65°C.

4.1.2 Mounting the EOSafe L/D supervision unit housing

Hardware + tools

- Drill
- Wood screws 4 x 25 mm
- Mounting on a fixed wall: Screws 4 x 25 mm and suitable anchors

► Mount the supervision unit housing

- 1 Drill 3 holes that align with the distances at the housing. See the figure below.

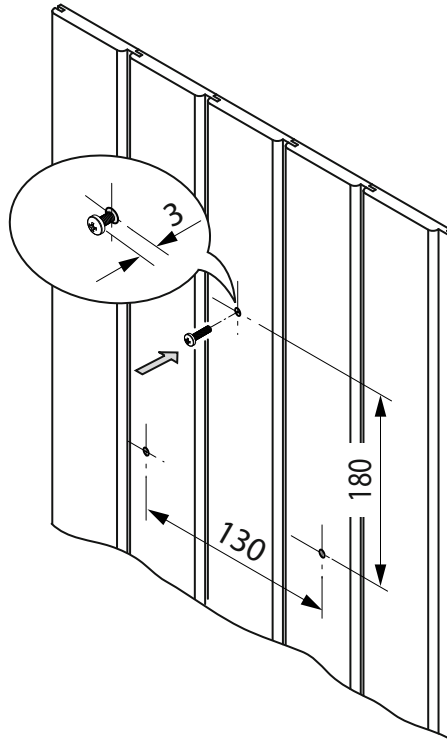

 Distances between drill holes (in mm)

- 2 Use an anchor if needed.
- 3 Screw in the top screw so that the screw head is 3 mm from the wall.

4 Loosen the housing screws (**A**) on the cover.

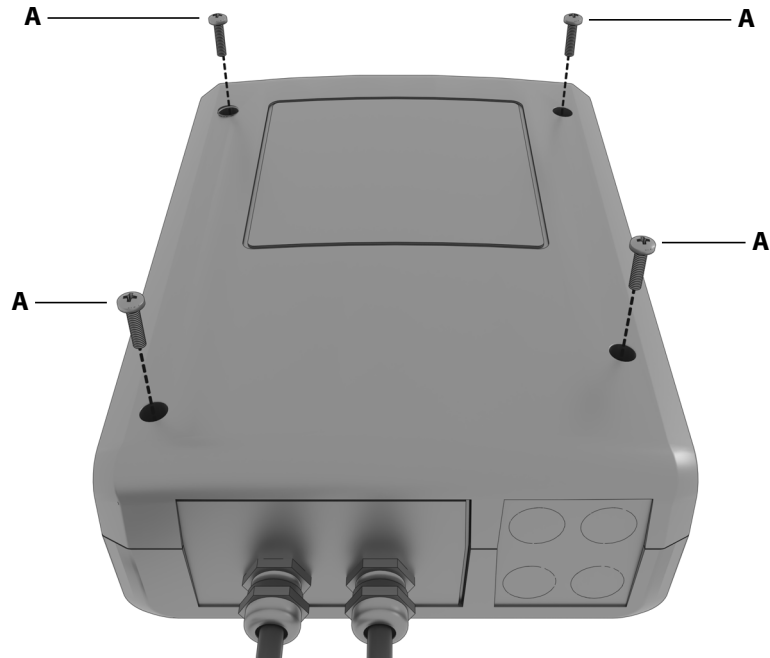

A Housing screws

 EOSafe L/D supervision unit housing

5 Hang the bottom of the housing on screw **B**.

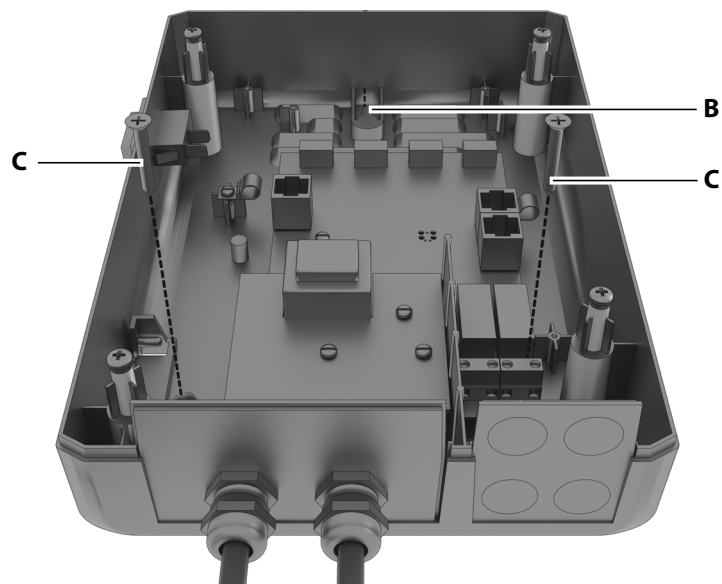

B Mount for the upper retaining screw

C Lower retaining screws

 Bottom piece of EOSafe L/D housing

6 Insert the lower screws (**C**).

- 7 Tighten the screws **C**.
- 8 Close the housing of the EOSafe L/D supervision unit.

4.2 Mounting the light barrier and reflectors

Information on mounting the EOSafe L/D supervision unit can be found in chapter 4.1 Mounting the supervision unit housing, [EN-25](#).

4.2.1 Mounting location

- Ambient temperature during operation, front light barrier: 10°C to 140°C
- Ambient temperature during operation, electronics light barrier: 10°C to 85°C
- Air humidity during operation 30% to 75% rel. air humidity

Preparing the mounting location

When preparing the mounting location for the light barrier, you must ensure that the following requirements are in place with respect to the position of the heater:

- The cabin ceiling above the heater should be level. If the cabin has a gable or a slanted ceiling, a level platform must be installed.
- There must be sufficient air to facilitate cooling above the hole for the light barrier. Remove the cabin insulation at the opening, if necessary.
- Ensure there are no beams or similar where the hole should be.
- Place the sauna heater in its designated location in the sauna cabin. Consult the installation and operating instructions that accompany the unit.
- Route the electrical connections so that the sauna heater does not have to be moved when mounting the unit.

4.2.2 Mounting the reflector

► Mount the reflector

- 1 Screw the reflector onto the heater using the 2 supplied screws.

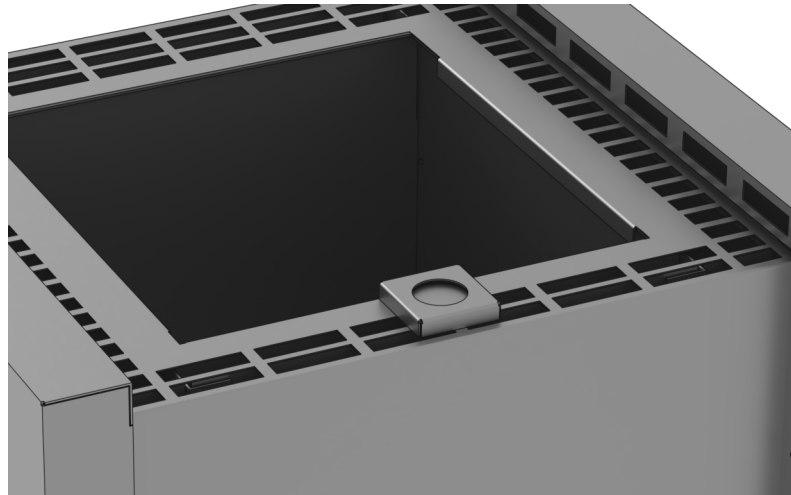



 EOSafe L reflector on the sauna heater (example)

- ① The light barrier must be mounted in such a way that it is perpendicular to and above the reflector. See ► Mount the light barrier,  EN-32.

4.2.3 Mounting the light barrier

The mounting procedure assumes that the ceiling is level.

If the cabin does not have a level ceiling, note the instructions in the section entitled Preparing the mounting location,  EN-30.

- Mount the light barrier,  EN-32
- Readjust during commissioning,  EN-35

Hardware + tools

- Drill with hole saw, diameter 60 mm
- Wood screws 4 x 25 mm, included in the scope of delivery
- Flathead screwdriver

Mounting

► Mount the light barrier

- 1 Drill a hole in the ceiling that is perpendicular to and above the reflector. The hole should have an inner diameter of 60 mm.

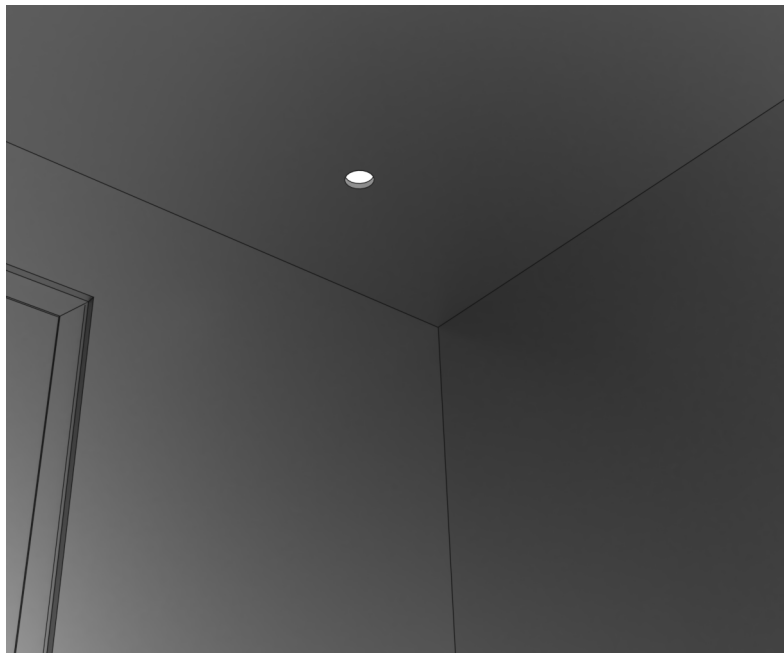

Maximum distance from light barrier to reflector for reflector diameter of 27 mm: 1.5 m.

Maximum distance from light barrier to reflector for reflector diameter of 52 mm: 2.25 m.

- ① Ensure that the light barrier housing is well ventilated upward and cannot accumulate dirt.
- ① Ensure that the opening is not too large. Because wood expands and contracts as temperatures fluctuate, the housing can come loose over time if the opening is too large.

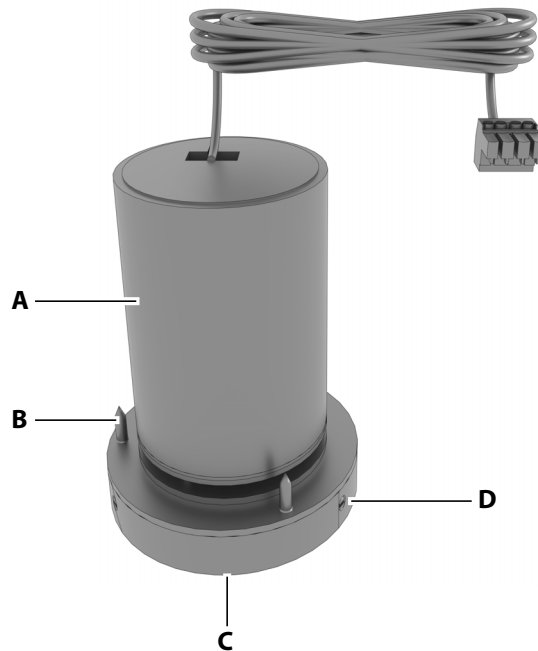

- A** Light barrier
 - B** Fixing screws
 - C** Adjusting screws for making fine adjustments (behind the front ring)
 - D** Set screws on front ring
- ☒ EOSafe L light barrier

- 2** Remove any dust or shavings from the hole you have just drilled so that the light barrier remains clean.
- 3** Unscrew the plug that is pre-attached to the cable.
 - ① Do not reattach the plug until you have pulled the cable into the supervision unit housing.
See 5.5 Connecting the light barrier, ☐ EN-55
- 4** Unscrew the set screws (D) on the front ring and remove the ring.
 - ① The front disk is placed loosely in the ring. Ensure that the disk does not fall or become scratched when removing the ring.

Mounting

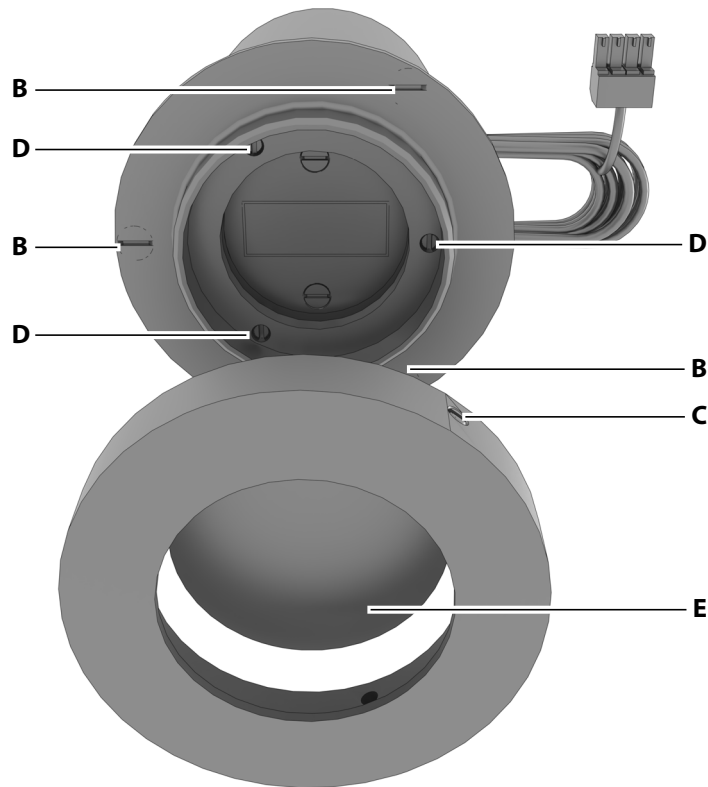

- B** Fixing screws **C** Set screws on front ring
D Adjusting screws for making fine **E** Front disk
 adjustments

 Light barrier, adjusting screws for making fine adjustments

- ①** Remount the ring after you have ensured that the light barrier is in the exact correct position. See
- ▶ Teach in the light barrier with EmoTouch 3, [EN-62](#)
 - ▶ Teach in the light barriers with EmoTec, EmoStyle or Econ, [EN-70](#)
- 5** Insert the light barrier housing into the hole and screw it to the ceiling with the screws (**B**).
- ①** Ensure that nothing is covering the light barrier so that the dust cover on the back can allow the housing to cool. Remove the insulation on the cabin ceiling as needed.
- 6** Attach the cable with the provided cable clip approx. 10 cm behind the light barrier so that it cannot be pulled.
- 7** Route the light barrier cable to the supervision unit.
- ①** The cable may not be routed together with live lines, e.g. they must be routed in separate cable conduits.
 - ①** The maximum length of the line from the light barrier to the supervision unit is 5 m.

► Readjust during commissioning

- 1 Complete all mounting and installation work first.
 - ① The light barrier is switched on when it is taught in during commissioning and the light beam can be readjusted for the reflector. See
 - Teach in the light barrier with EmoTouch 3, [EN-62](#)
 - Teach in the light barriers with EmoTec, EmoStyle or Econ, [EN-70](#)
- 2 Start commissioning.
- 3 Align the light beam so it is centric with the reflector. Screw in the three brass adjusting screws (**A**) on the bottom of the light barrier until the light beam hits the centre of the reflector.

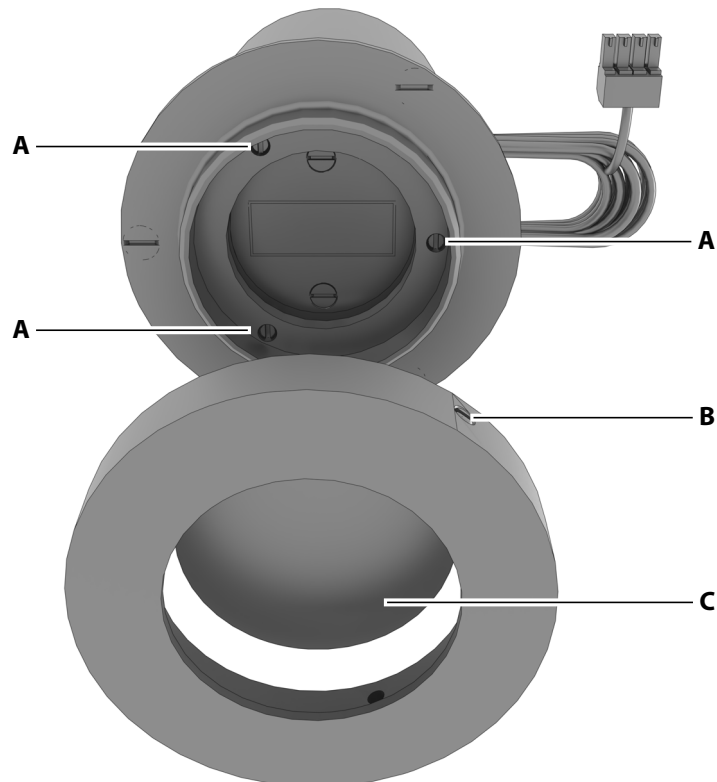

A Adjusting screws for making fine adjustments **B** Set screws on front ring
C Front disk

- ① Use a small flathead screwdriver to adjust the sleeve with the light sending and receiving unit by approx. 3-5° in all directions.
- 4 Place the front ring with the front disk inserted (**C**) on the light barrier.
 - ① The front disk is loosely placed in the front ring.
 - ① Ensure that the front disk is clean and free of dust.

- 5 Screw in the set screws on the front ring (**B**) so they are evenly tight.
 - ① Do not exert excessive force when tightening the set screws because the threads are made of plastic.
- 6 Tighten the screws again after 10 hours of operating time.

4.3 Mounting the door supervision device and magnet

Information on mounting the EOSafe L/D supervision unit can be found in chapter 4.1 Mounting the supervision unit housing, [EN-25](#).

4.3.1 Mounting location

- The mounting location must be free of dust and grease so that adhesive strips can be used.
- Attach the door supervision device to the upper part of the door. If you attach it to the lower part of the door, it could become damaged, for example, when the floor is cleaned.

4.3.2 Mounting the door supervision device

Observe the notes in section Magnet, distances, positions, [EN-23](#) when mounting the door supervision device.

- The door supervision device and magnet housing may be mounted only in the specified positions and at the specified distances.
 - ☐ Distances and offsets for magnet positioning, [EN-38](#)
- Mill out the door frame or door panel as needed to ensure that the offset or distance is correct.
- Do not attach the magnet housing before commissioning.

► Mount the door supervision device

- 1 Loosen the protective film from the adhesive strip on the back of the door supervision device housing.
 - ① Ensure that the area where the strips will be applied is free of dust and grease.
- 2 Affix the door supervision device to the door frame and firmly press the housing into place.

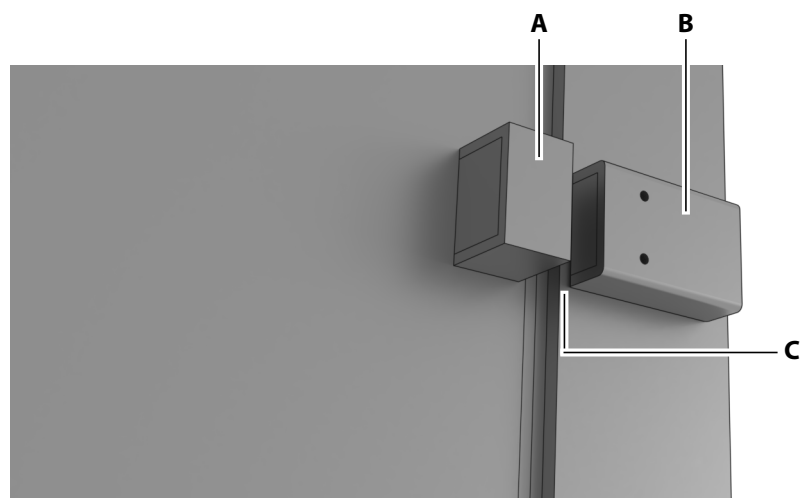

A Magnet housing with magnet **B** Door supervision device
C Distance

① The adhesive strip has fully bonded after 72 hours.

- 3 Route the pre-attached door supervision device cable to the supervision unit.
 - ① The cable may not be routed together with live lines, e.g. they must be routed in separate cable conduits.
 - ① The length of the line from the door supervision device to the supervision unit is 5 m. As an alternative an RFID element with 20 m connection cable is available, see Accessories (optional), EN-15
 - ① Ensure that the cable is properly secured so that it is not pulled too tightly at the door supervision device.

Mounting

4.3.3 Aligning the magnet and mounting the magnet housing

Depending on the type of cabin door (offset and distance), the magnet must be aligned in the magnet housing and fixed with the fillers.

Offset 0 mm

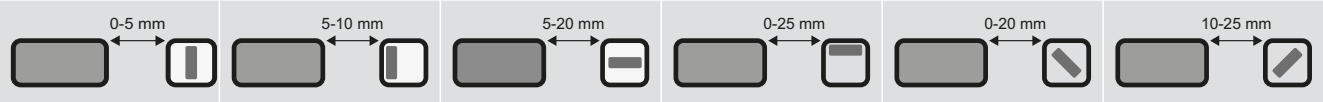

Offset 10 mm

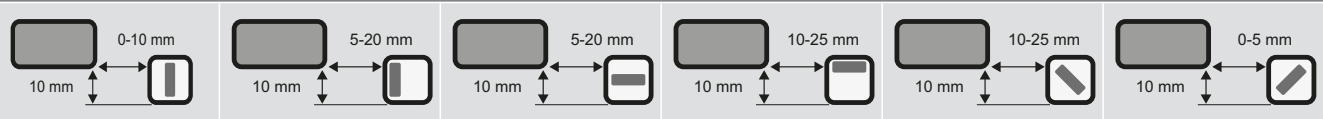

Offset 20 mm

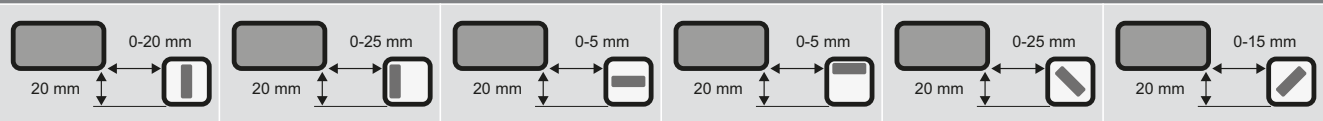

Offset 30 mm

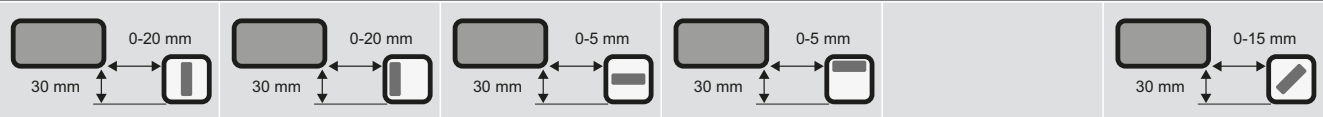

Offset 40 mm

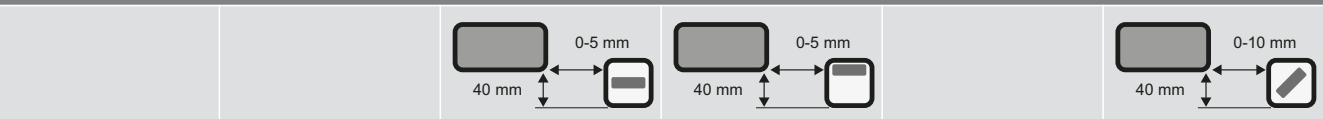

Offset 50 mm



 Distances and offsets for magnet positioning

When commissioning the door supervision device, adhere the magnet housing to the cabin door.

Depending on the offset and distance, the alignment of the magnet must be adjusted. Fix the magnet in the magnet housing with the fillers. Keep the offset and distance to a minimum when mounting the door supervision device to ensure that it works properly.

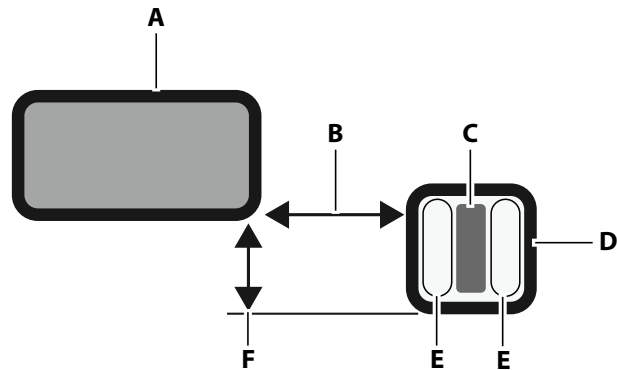

- A** Door supervision device
- B** Distance
- C** Magnet
- D** Magnet housing
- E** Fillers
- F** Offset



 Door supervision device and magnet mounted

► Align the magnet in the magnet housing

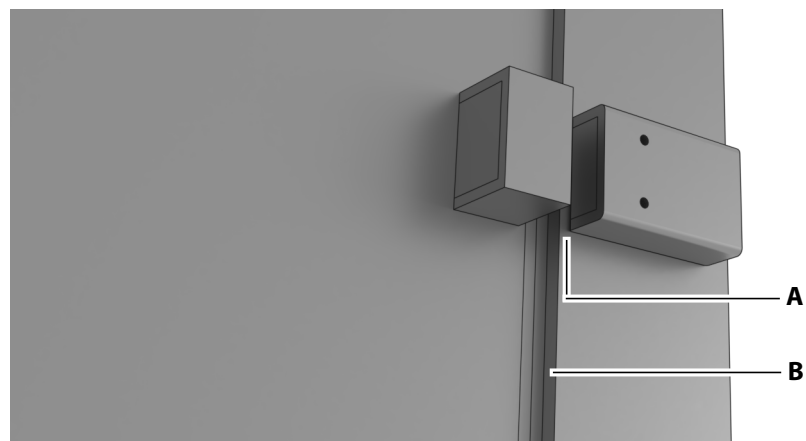
- 1 Measure the offset and distance at the mounting location of the door supervision device.



- A** Distance
- B** Offset

① For distances and offset measurements, see  Distances and offsets for magnet positioning,  EN-38

Mounting

- 2 Place the magnet and the required fillers in the magnet housing.

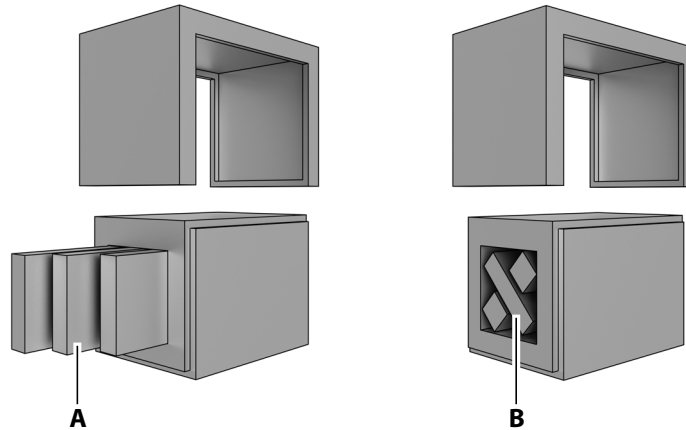

- A** Magnet in vertical position in the housing
B Magnet in diagonal position in the housing

- 3 Close the magnet housing. Slightly bend the cover of the magnet housing up to push it over the magnet housing.

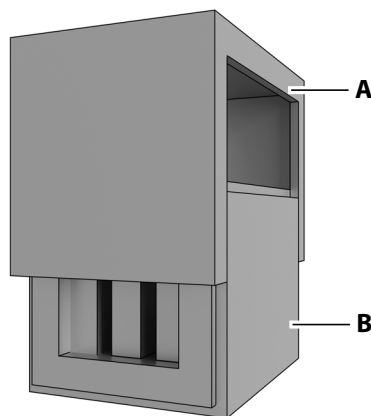

- A** Cover
B Magnet housing

ⓘ Do not affix the magnet housing with the magnet to the cabin door before commissioning.

- 📖 6.2.3 Teaching in the door supervision device, 📄 EN-65
 6.3.3 Teaching in the door supervision device, 📄 EN-73

5

Installation

This chapter describes how to install EOSafe L/D.

NOTICE

Equipment damage

Corrosive environments or environments with high levels of saline in the air could damage lines and circuit boards.

- ▶ Use EOSafe L/D only in an environment with no corrosive substances.

5.1 Routing cables in the EOSafe L/D supervision unit

The network cable and the connecting cable for the relay box are pre-attached to the supervision unit. This terminal area is not accessible in the supervision unit and has a cover to protect it from being touched as well as a warning label.

NOTICE

Equipment damage

Cables that are not secured by the pre-attached cable clip on the circuit board can enter the high voltage current side and cause damage to the unit.

- ▶ Secure cables in the pre-attached cable clip.

All cables that are connected to the EOSafe supervision unit's circuit board must be routed in the housing according to a fixed layout and fixed with the pre-mounted cable clip.

Installation

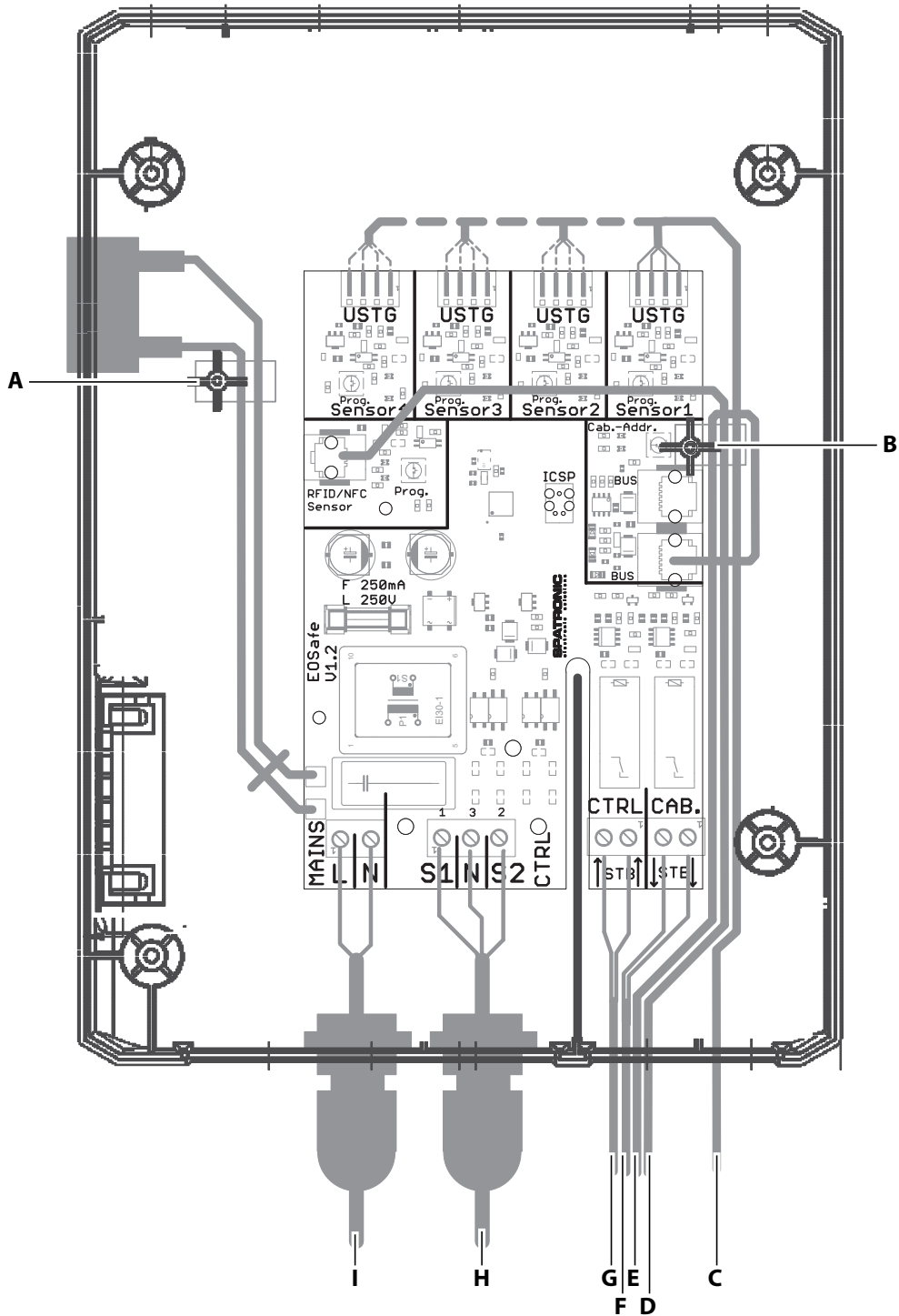

- | | | |
|---|---|---|
| A Cable clip for line to switch | D Door supervision device | G Safety temperature limiter terminal from relay box |
| B Cable clip for light barriers and bus cables | E Sauna bus | H Start-up status of sauna relay box (pre-mounted) |
| C Light barriers 1-4 | F Safety temperature limiter sensor in the cabin | I Mains connection (pre-attached) |

Cable routing in supervision unit housing

Route the cables in the housing through the tracks only as shown in the figure and secure them in the pre-attached cable clips.

The start-up status cable and mains connection are pre-attached.

The connections for the light barriers, door supervision device, safety temperature limiter and sauna bus are fed through the housing openings.

The cable bushings are closed and must be pierced with a suitable tool, e.g. a screwdriver, in order to be able to insert the relevant cable.

Only pierce the cable bushings which are actually required for the planned installation according to the following scheme.

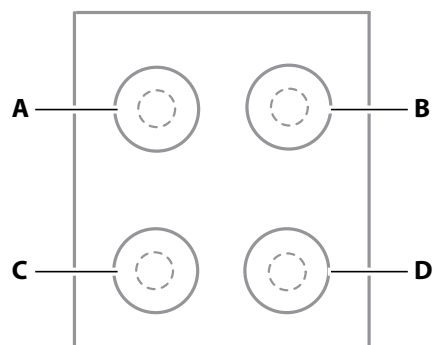

- | | |
|--|-------------------------------------|
| A Safety temperature limiter relay box
Safety temperature limiter sensor | B Light barriers 1-2 |
| C Sauna bus (S-Bus) | D Light barriers 3-4
RFID |
-  Cable bushings on the bottom of the housing

Connection diagram

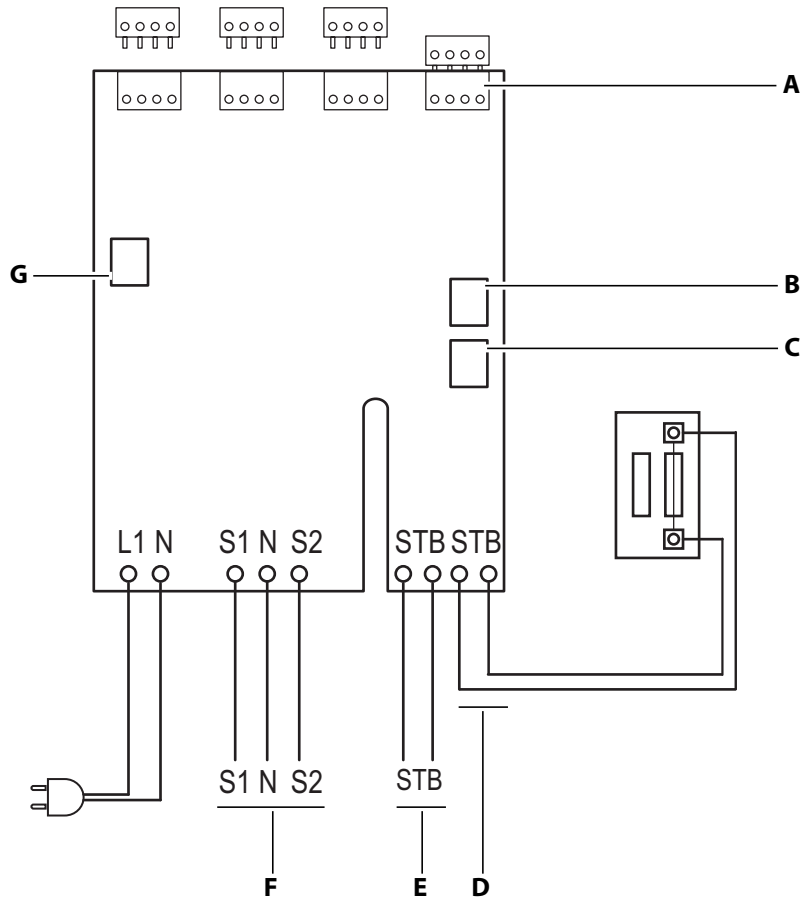

- A** Light barrier connections
- B** Sauna bus (S-Bus)
- C** Sauna bus (S-Bus)
- D** Safety temperature limiter to cabin
- E** Safety temperature limiter from relay box
- F** Connections for start-up status
- G** Socket for door supervision device

☒ Connection diagram

Light barrier connections (A)

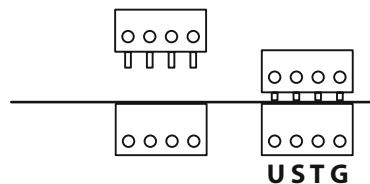

- U** Brown
- T** Black
- S** Blue
- G** White

☒ Light barrier cable assembly

Connections (F) to EmoTec, Econ sauna relay box

Wire labels: 1=S1, 2=S2, 3=N

5.2 Connecting the safety circuit to EOSafe L/D

EOSafe is connected in the safety circuit between the relay box and the safety temperature limiter. That is why the supervision unit circuit board has a safety temperature limiter input from the relay box and a safety temperature limiter output to the safety temperature limiter.

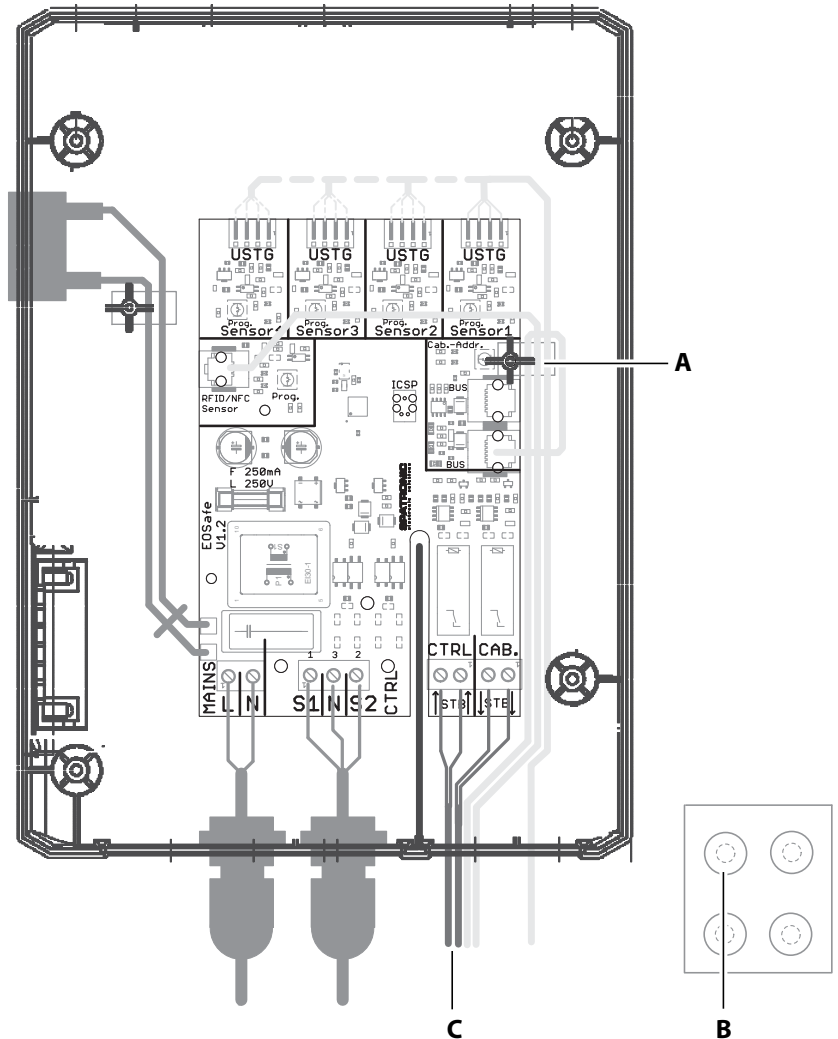

► Connect the safety circuit

- 1 DANGER! Ensure that there is no voltage present on the circuit board. Disconnect the EOSafe supervision unit from the mains supply.
- 2 Remove the housing cover. See ► Mount the supervision unit housing, EN-28.

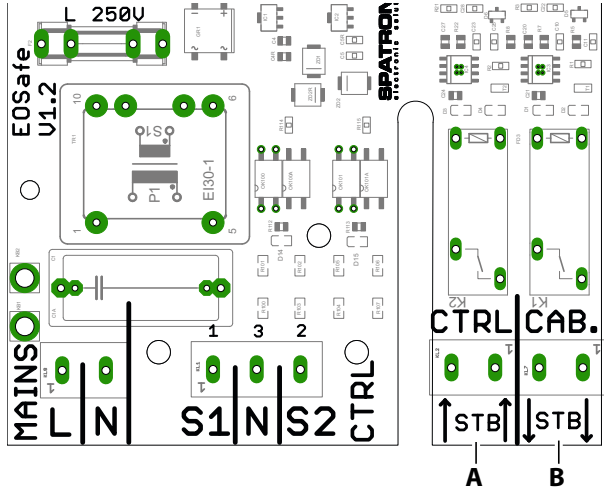

- A** Cable clip
- B** Cable feed opening to relay box and safety temperature limiter sensor
- C** Cable feed for safety circuit
- Safety circuit connection

Installation

- 3 Pierce the cable bushings **B** with a suitable tool, e.g. a screwdriver.
- 4 Feed the cables (**C**) on the housing through the cable feed opening (**B**).
- 5 Route the cable as shown in the figure  Safety circuit connection,  EN-45.
- 6 Connect the safety circuit from the relay box to the safety temperature limiter terminal on the circuit board (**A**).

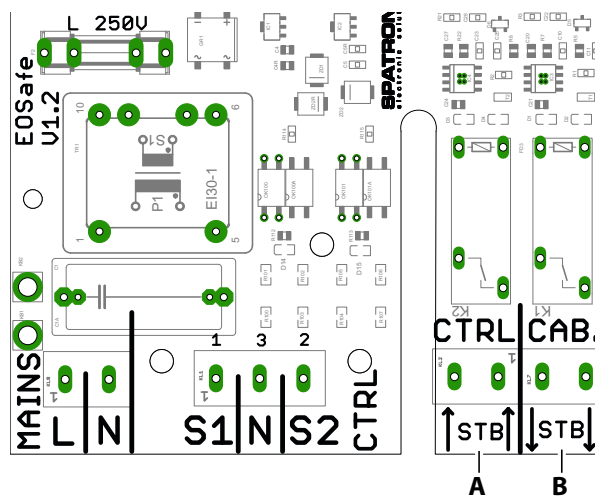

- A** Cable from relay box to EOSafe supervision unit
B Cable from EOSafe supervision unit to relay box

- 7 Connect the safety circuit toward the safety temperature limiter in the cabin to safety temperature limiter terminal B on the circuit board.
 -  If the cable routing is not in an enclosed system (e.g. in a cable conduit or in wood), secure the cables with cable clips so they cannot be pulled.
- 8 Close the housing of the EOSafe L/D supervision unit.

5.3 Connecting the lines for start-up status

You must open the sauna relay box to complete this task. Review the following graphics to gain an overview of the corresponding circuit board connections.

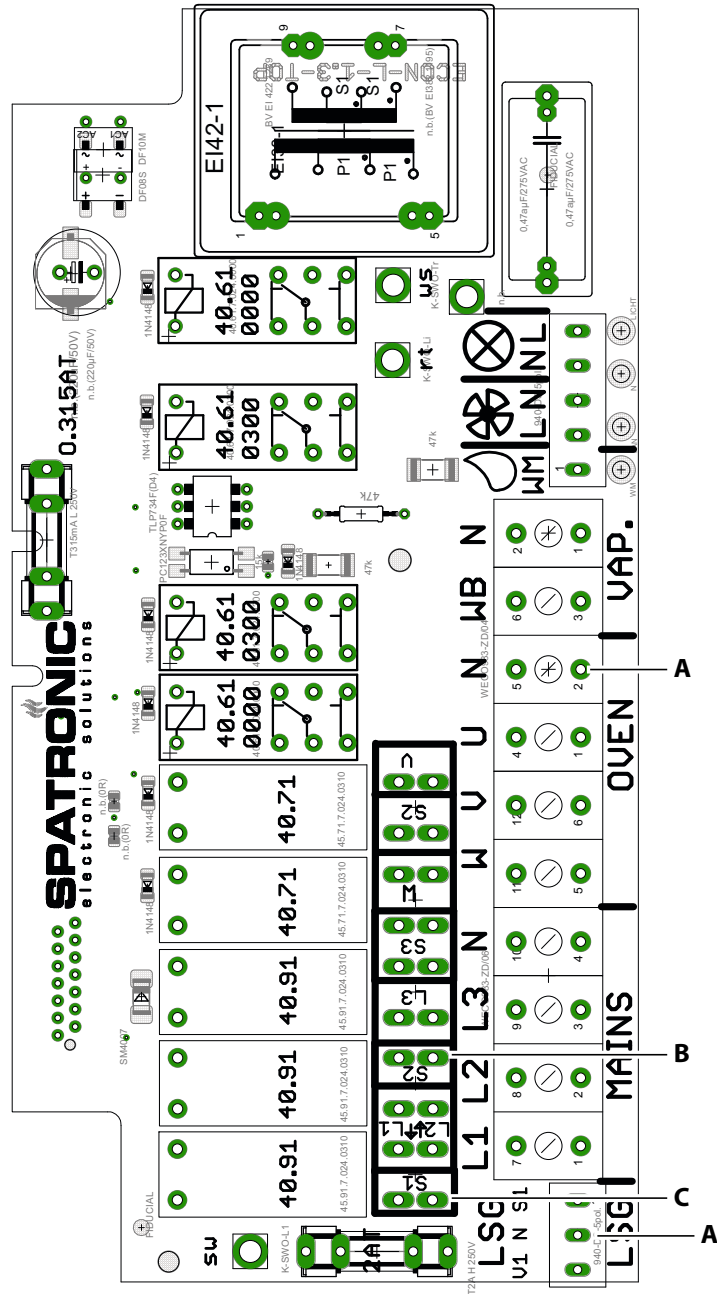

- A** Neutral conductor
- B** Flat pin S2
- C** Flat pin S1
- Relay box of circuit board Econ D1-D3, H1-H3

Installation

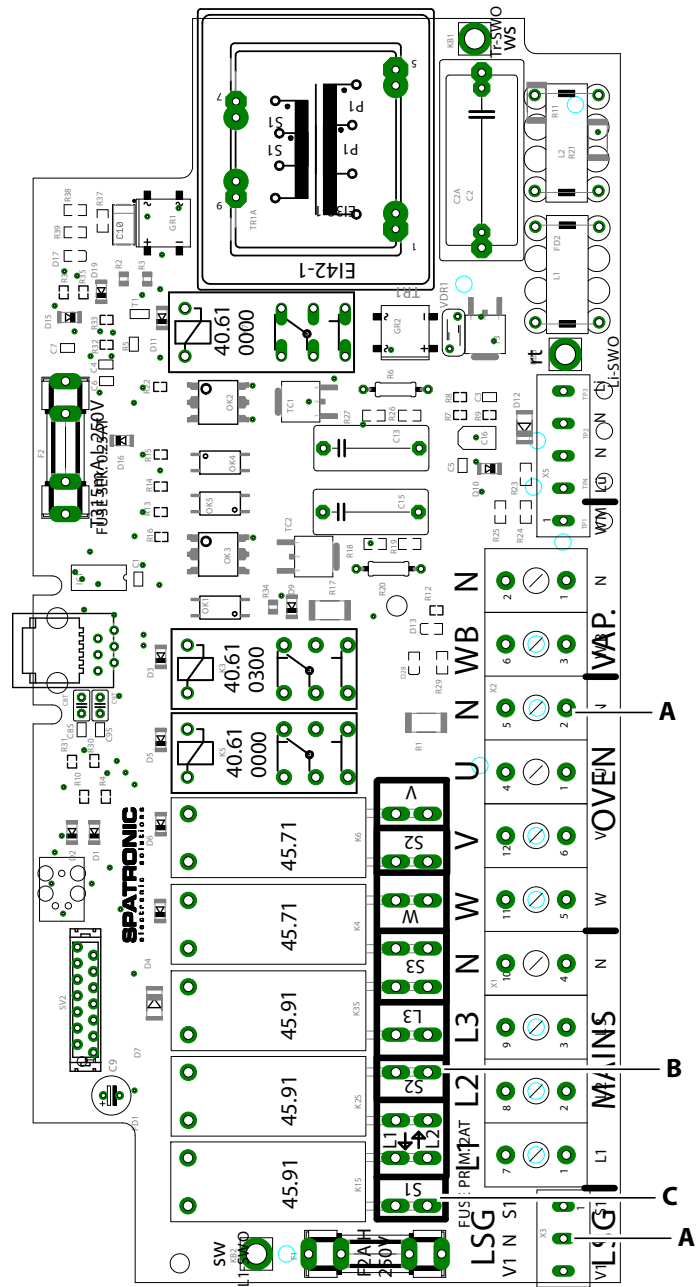

- A** Neutral conductor
 - B** Flat pin S2
 - C** Flat pin S1
- ☒ Relay box of circuit board Econ D4, H4

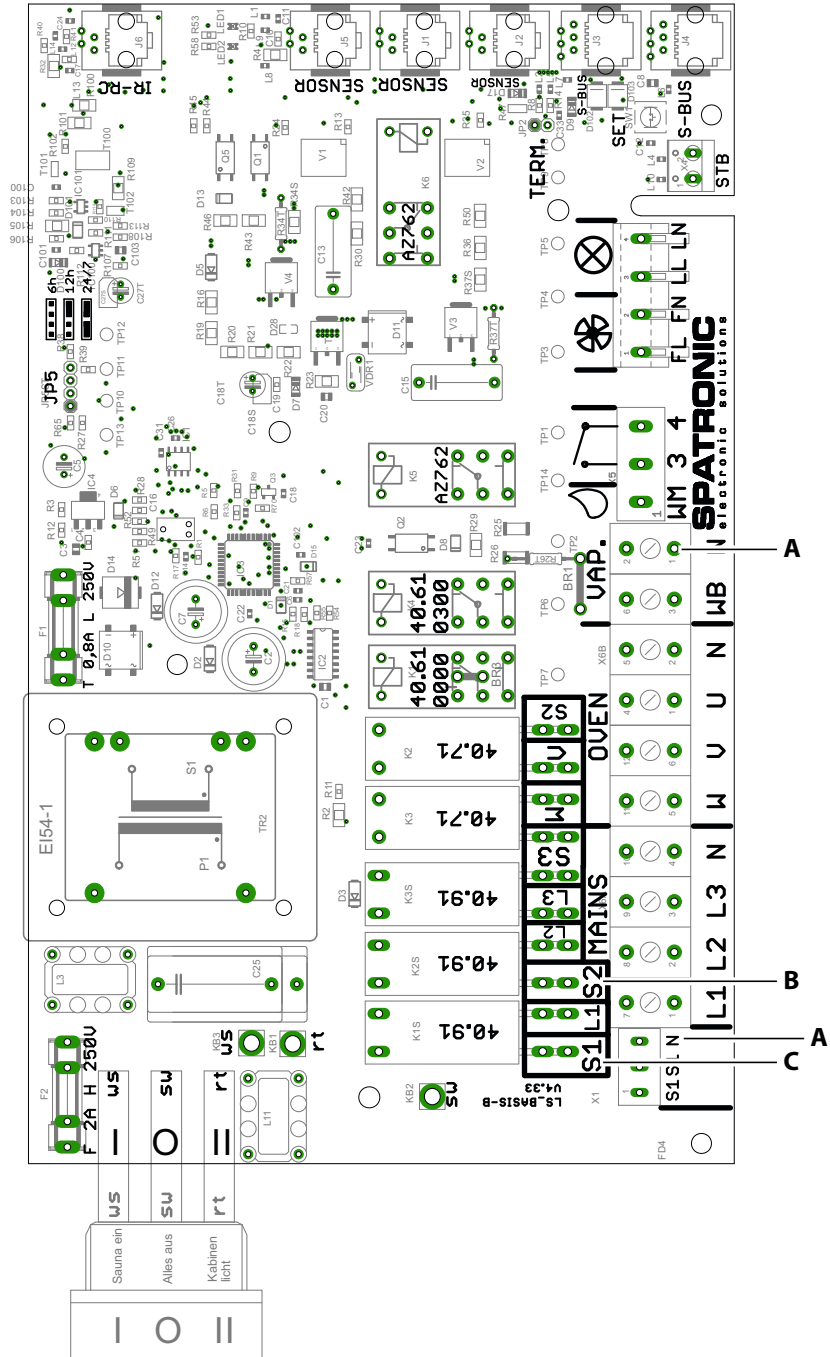

- A** Neutral conductor
- B** Flat pin S2
- C** Flat pin S1
- Relay box of circuit board EmoTec/EmoTouch 3

The cables are pre-attached to the EOSafe L/D supervision unit. To connect to the relay box, the wires for the flat plug are labelled with 1 for connection S1, 2 for connection S2 and 3 for connection N.

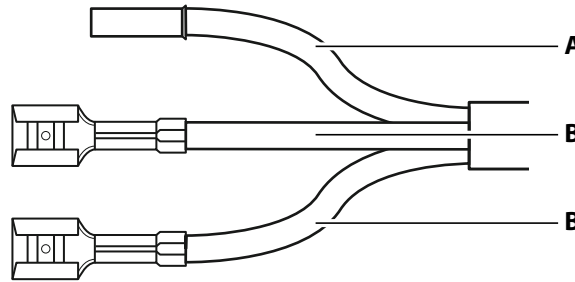

A 3=N

B 1=S1, 2=S2

Wire labels

► **Connect lines S1, S2 and N to the sauna relay box**

- 1 Switch off both EOSafe and the relay box and completely disconnect both from the power supply.
- 2 Remove the housing cover from the relay box.
- 3 **DANGER!** The circuit board may still have an electrical current even if it has been switched off. The connection should be established only by trained personnel.

On the sauna relay box, attach flat plug S1 to connection **S1**.

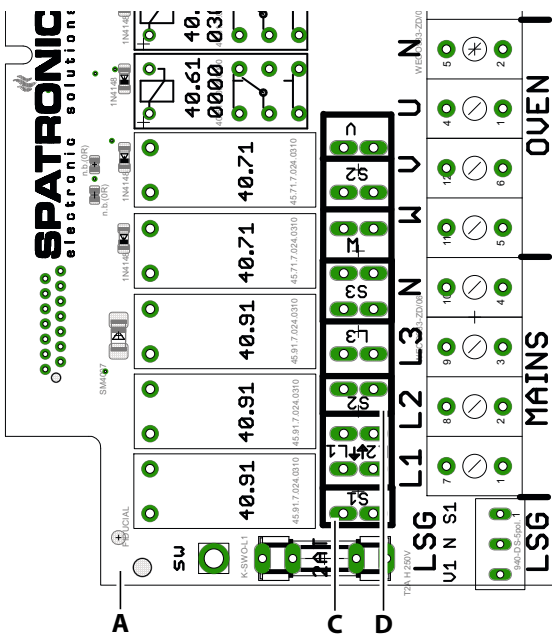

A Econ relay box
B EmoTec relay box

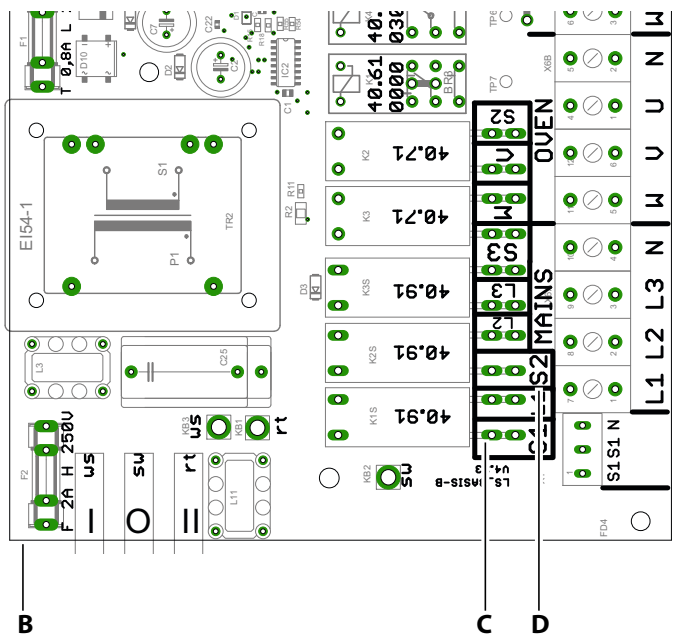

C Connector pin S1
D Connector pin S2

- 4 Attach flat plug S2 to connection **S2**.
- 5 Connect the neutral conductor.
 - ① The terminal is either **C** or **Cc**, depending on the installation.

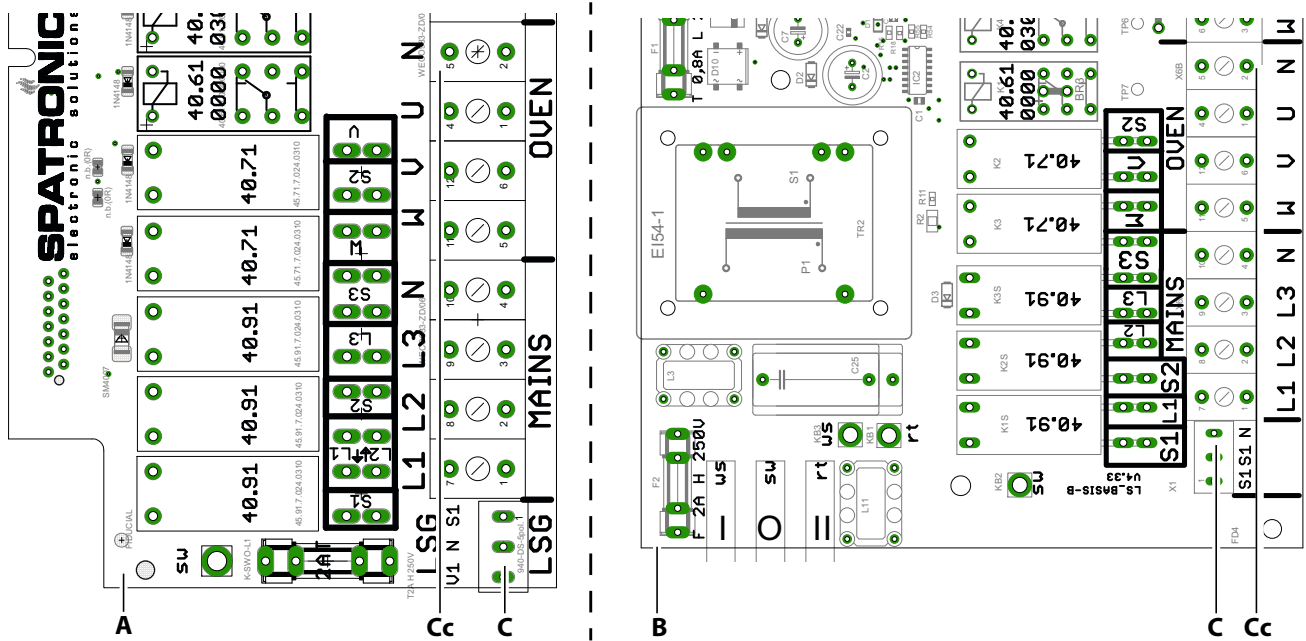

A Econ relay box
B EmoTec relay box

C Connection for neutral conductor
Cc Alternative connection for neutral conductor

- 6 Close the housing of the relay box.

5.4 Connecting the sauna bus cable (optional for EmoTec, EmoStyle, EmoTouch 3)

NOTICE

Incorrect data transfer due to incorrect installation

The software does not recognise the EOSafe L/D. Data is transferred incorrectly.

- ▶ Only plug S-Bus cables into S-Bus jacks on the circuit board.
 - ▶ Connect only one EOSafe L/D per cabin.
-

NOTICE

Electronics malfunctions

Routing data and power supply lines together can lead to electronics malfunctions because, e.g. because the sensor will not be detected.

- ▶ Do not route sensor and sauna bus lines together with power supply lines.
 - ▶ Route separate cable conduits.
-

► Connect the sauna bus cable (optional)

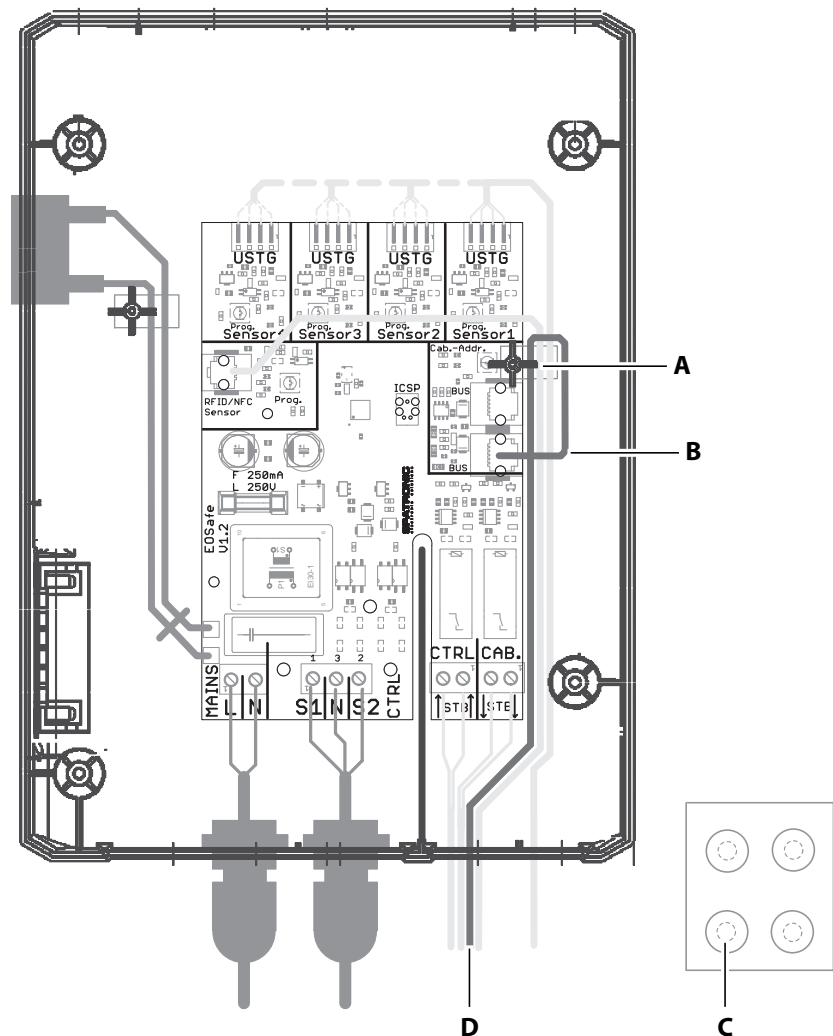

- 1 **DANGER!** Ensure that there is no voltage present on the circuit board. Disconnect the EOSafe supervision unit from the mains supply.
- 2 Remove the housing cover. See ► Mount the supervision unit housing, EN-28.



- | | |
|--|-----------------------------|
| A Cable clip | C Cable feed opening |
| B Sauna bus jack | D Cable feed |
|  Sauna bus connection | |

- 3 Pierce the cable bushings **C** with a suitable tool, e.g. a screwdriver.
- 4 Feed the cable (**D**) on the housing through the cable feed opening (**C**).
- 5 Open the cable clip **A** by pushing from the side in the direction of the housing wall.

Installation

- 6 Route the sauna bus cable as shown in the figure  Sauna bus connection,  EN-53.
 - ① Ensure that you guide the cable through the cable clip (**A**).
- 7 Plug the sauna bus on the circuit board into the jack (**B**).
- 8 Close the cable clip by pressing down firmly until it clicks into place.
- 9 Close the housing of the EOSafe L/D supervision unit.

5.5 Connecting the light barrier

► Connect the light barrier

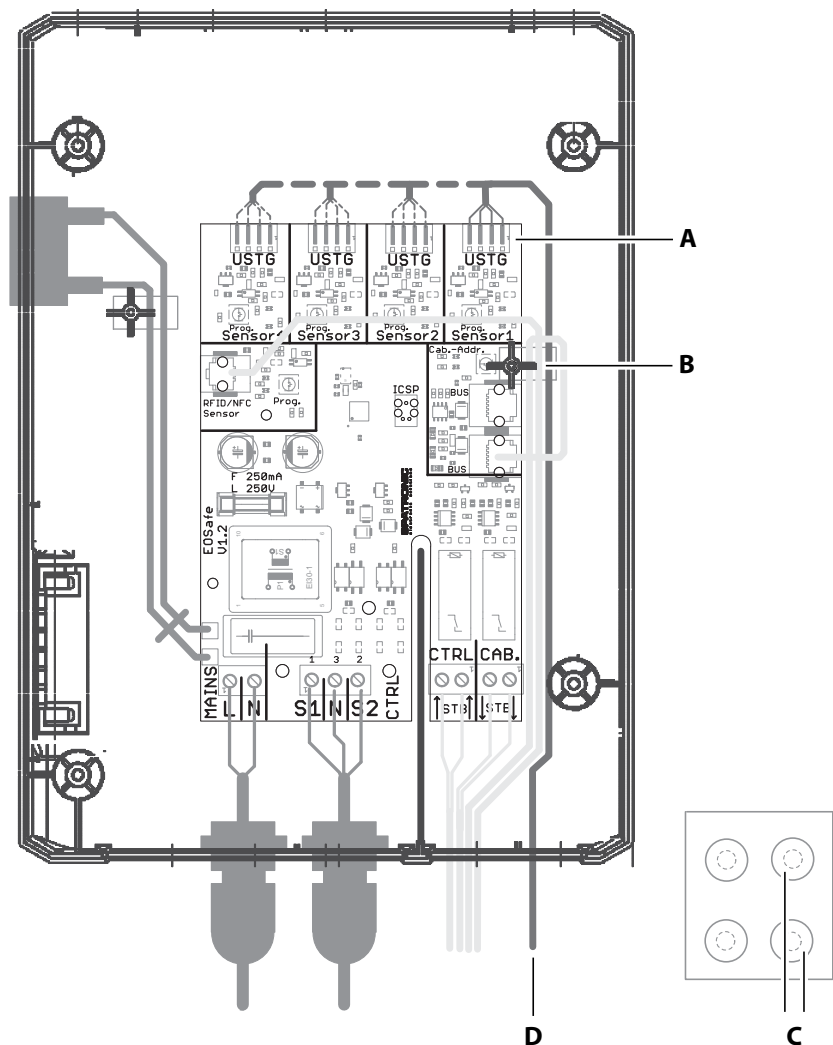

- 1 **DANGER!** Ensure that there is no voltage present on the circuit board. Disconnect the EOSafe supervision unit from the mains supply.
- 2 Remove the housing cover. See ► Mount the supervision unit housing, EN-28.



- | | |
|--|------------------------------|
| A Connection for light barrier | C Cable feed openings |
| B Cable clip | D Cable feed |
|  Connection for light barrier | |

- 3 If necessary, unscrew the plug from the cable **D** of the light barrier.
 - ① Typically, the plug has already been unscrewed when the light barrier was mounted.

Installation

- 4 Pierce the cable bushings **C** with a suitable tool, e.g. a screwdriver.
- 5 Feed the cable (**D**) on the housing through the cable feed openings (**C**).
- 6 Open the cable clip **B** by pushing from the side in the direction of the housing wall.
- 7 Route the cable of the light barrier as shown in the figure. See  Connection for light barrier,  EN-55.
- 8 Screw in the cables of the light barrier at the jack as shown.

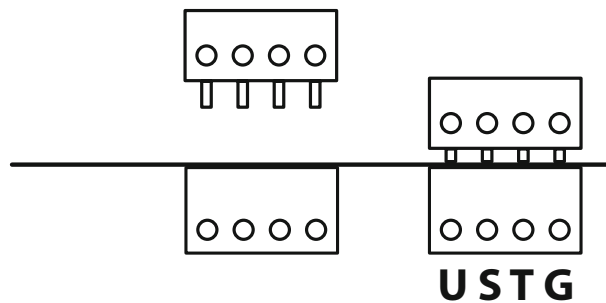

U Brown
T Black

S Blue
G White

 Light barrier cable assembly

- 9 Insert the plug in the connection for the light barrier (**A**).
- 10 Close the cable clip by pressing down firmly until it clicks into place.
- 11 Close the housing of the EOSafe L/D supervision unit.

5.6 Connecting the door supervision device

► Connect the door supervision device

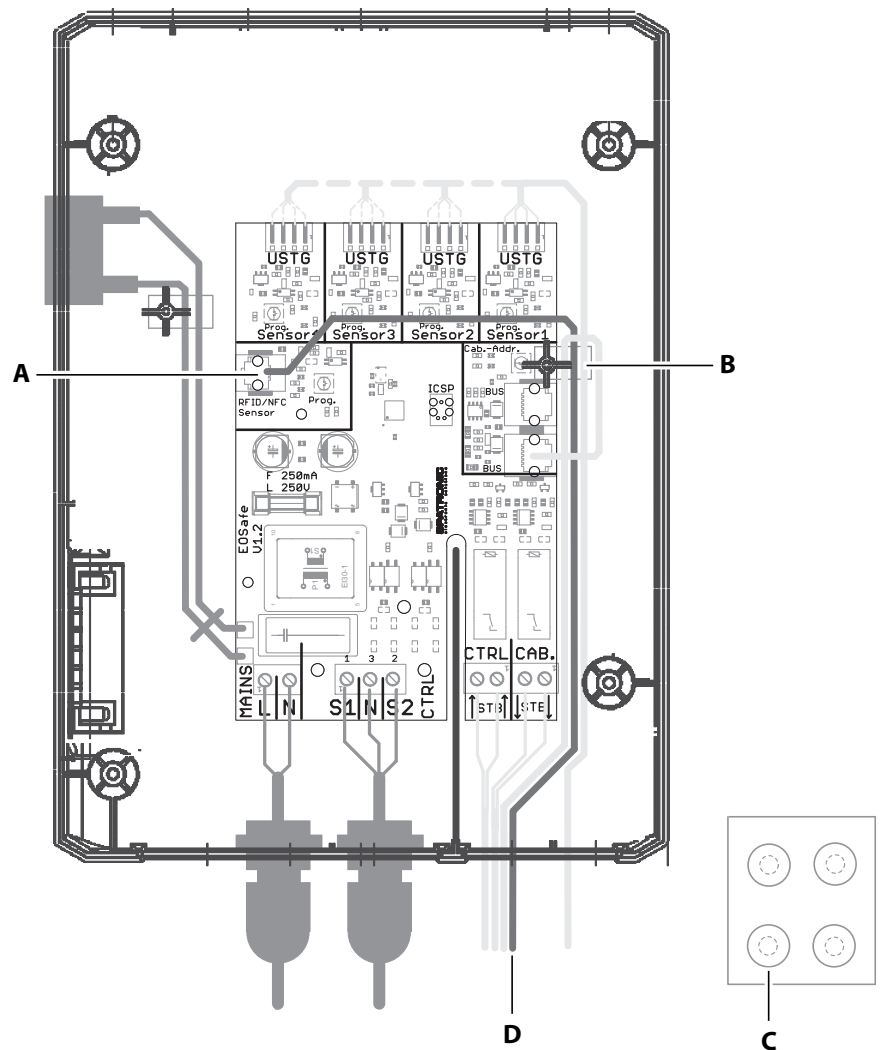

- 1 DANGER! Ensure that there is no voltage present on the circuit board. Disconnect the EOSafe supervision unit from the mains supply.
- 2 Remove the housing cover. See ► Mount the supervision unit housing, EN-28.



- A** Connection for door supervision device
- B** Cable clip
- C** Cable feed opening device
- D** Cable feed
-  Connection for door supervision device

- 3 Pierce the cable bushings **C** with a suitable tool, e.g. a screwdriver.
- 4 Feed the cable (**D**) on the housing through the cable feed opening (**C**).

Installation

- 5 Open the cable clip **B** by pushing from the side in the direction of the housing wall.
- 6 Route the cable of the door supervision device as shown in the figure. See  Connection for door supervision device,  EN-57.
- 7 Insert the cable on the circuit board into the jack **A**.
- 8 Close the cable clip by pressing down firmly until it clicks into place.
- 9 Close the housing of the EOSafe L/D supervision unit.

6

Commissioning

This chapter describes how to commission EOSafe L/D.

Carry out the following steps when commissioning EOSafe L:

- ▶ Program the address, [EN-60](#)
 - ▶ Teach in the light barrier with EmoTouch 3, [EN-62](#)
 - ▶ Teach in the light barriers with EmoTec, EmoStyle or Econ, [EN-70](#)
- 6.5 Commissioning checks, [EN-79](#)

Carry out the following steps when commissioning EOSafe D:

- ▶ Program the address, [EN-60](#)
 - ▶ Teach in the door supervision device into the system with EmoTouch 3, [EN-65](#)
 - ▶ Teach in the door supervision device with EmoTec, EmoStyle or Econ, [EN-73](#)
- 6.5 Commissioning checks, [EN-79](#)

NOTICE

Equipment damage

Corrosive environments or environments with high levels of saline in the air could damage lines and circuit boards.

- ▶ EOSafe L/D may only be used in a non-corrosive environment.

6.1 Configuring addresses for multi-cabin installations (optional)

You only need to configure cabin addresses in a multi-cabin installation with the EmoTouch 3 control panel. The address of the cabin you want to control must be configured in the EOSafe L/D for this purpose.

Installations for EmoTec, EmoStyle, EmoStyle i, EmoTec IR, InfraStyle, InfraStyle i and Econ always require cabin address 1.

► Program the address

- 1 Disconnect the EOSafe supervision unit from the mains supply.
- 2 Remove the housing cover. See ► Mount the supervision unit housing, EN-28.
- 3 **DANGER!** The covered area of the circuit board is under live current. Do not remove the cover plate.
Plug in the supervision unit to the mains supply.
- 4 Press the programming button **B** for approx. 5-6 seconds until the red LED **A** is illuminated.
ⓘ Programming mode is active. The green LED **C** goes off.

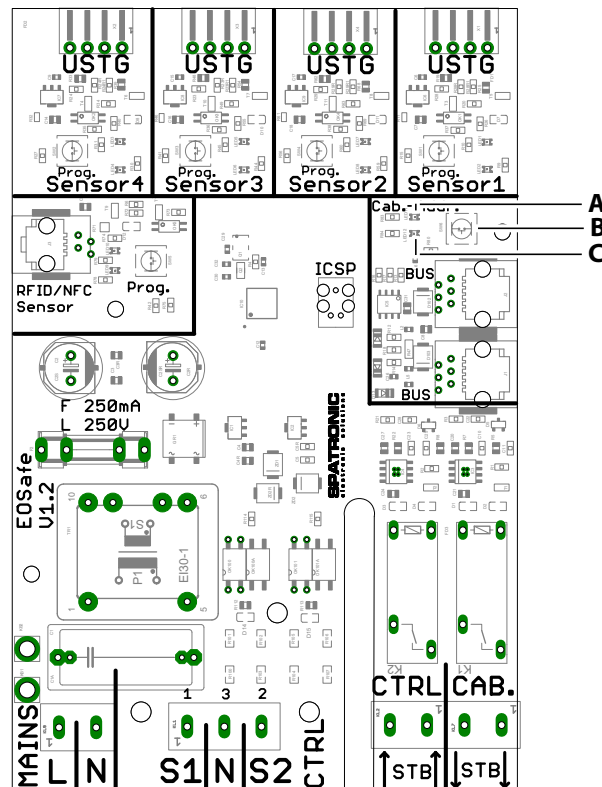

A Red LED
C Green LED

B Programming button

- 5** Briefly but firmly press the programming button once.
- 6** Wait until the green LED **C** flashes and count how many times it flashes.
 - The green LED flashes 1 to 8 times, depending on the new cabin address, for example twice for cabin 2.
- 7** Repeat steps **5** and **6**, until the desired cabin address has been set.
 - ① Note that each time you press the programming button, the cabin address increases by one. Once address 8 is reached, the count starts over with address 1.
 - If the button is not pressed for approx. 15 seconds, programming mode ends. The red LED goes off and the green LED starts flashing. The new address is saved.
- 8** In the *Softwarestand* [Software status] menu of the EmoTouch 3 control panel, search for the entry *M.-Saf.* or *M.-SEC*.
 - ① If the entry *M.-Saf.* or *M.-SEC* exists, EOSafe has been detected.
- 9** Repeat programming if the entry *M.-Saf.* or *M.-SEC* is not displayed.
 - ① Please note that the address increases by one each time you press the programming button, e.g. from 4 to 5.
- 10** Close the housing of the EOSafe L/D supervision unit.

6.2 Commissioning with EmoTouch 3

The light barriers and/or the door supervision device must be taught in for commissioning. Commissioning with EmoTouch 3 is possible with software version R2.08 or higher.



6.2.1 Teaching in the light barriers

You will have to teach in all light barriers that are installed and plugged in to the circuit board. The safety circuit is interrupted if light barriers are connected but not taught in.

The sauna heater may not be on when light barriers are taught in.

Once you have installed EOSafe L/D, a second person is needed in the cabin to realign the light barriers and teach them in because you cannot use EOSafe D to open the cabin without switching off the system.

► Teach in the light barrier with EmoTouch 3

- 1 Press  for 3 seconds.
- 2 Enter code **9851** and confirm with .

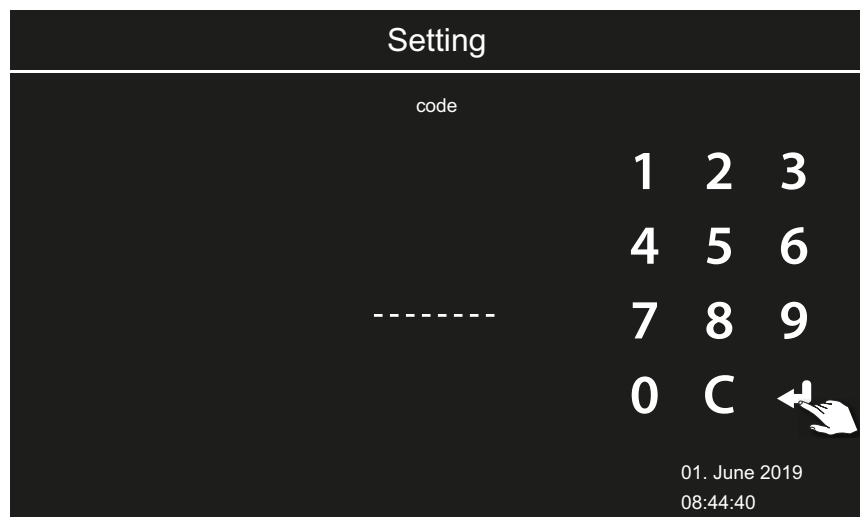

- 3** Select the light barrier you want to teach in by choosing **A**.

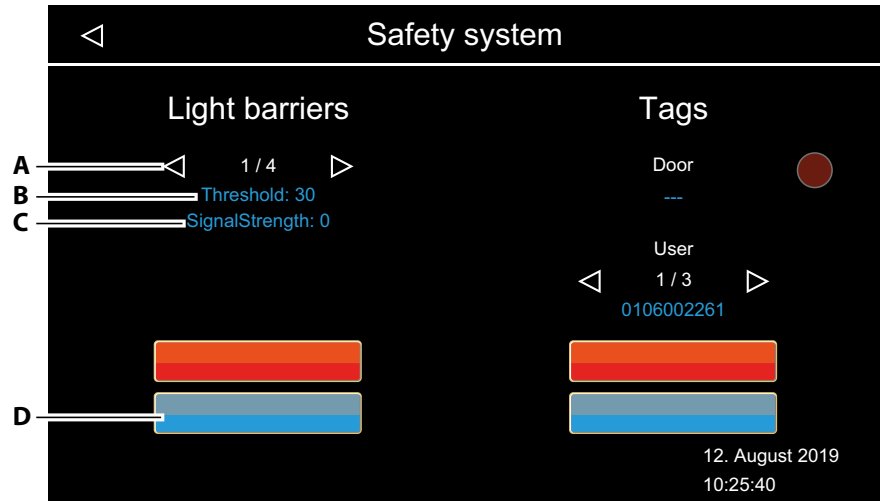

- A** Select light barrier **B** Taught-in threshold
C Current signal value **D** Start and complete teach-in mode

- 4** Tap **D**.

- ① The light barrier is in teach-in mode and generates a permanent point of light.
- ① The light barrier's taught-in value **B** is displayed. The light barrier's current signal value **C** is displayed only if the light barrier is switched on and is receiving a signal.

- 5** Align the point of light in the cabin (as needed) with the 3 adjusting screws so it shines directly on the reflector.

See ► Readjust during commissioning, □ EN-35.

- ① The highest possible signal value is needed for smooth operation. The light barrier's signal value **C** must have a value between 16 and 250.
- ① Realign the light barriers if the signal value **C** is not within this range.

- 6** Tap **D** to exit teach-in mode.

- ① The threshold is updated (signal value/2).



- 7** Repeat step **5** until an optimal signal value is achieved.

- ① After aligning the light beam, the signal value must always be updated on the control panel.
- The light barrier has been taught in as soon as fine alignment and updating of the signal value are complete.
- ① Remember to place the front ring with the protective disk back in place at the taught-in light barrier in the cabin and tighten it with the set screws.

- 8 Repeat these steps for all connected light barriers.

6.2.2 Deleting light barriers

► Delete light barriers with EmoTouch 3

- 1 Press  for 3 seconds.
- 2 Enter code **9851** and confirm with .

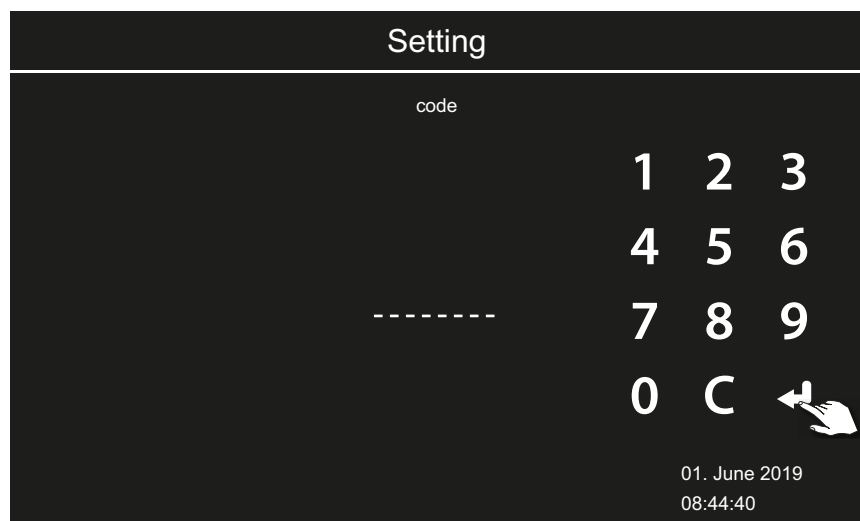

- 3 Tap **A** to select the light barrier you want to delete.



A Select light barrier

B Delete taught-in values

- 4 Tap **B** to delete the set values.
- ① The threshold value is set to 0 (zero).
The safety circuit is interrupted as long as one light barrier with a deleted threshold value is still connected.

- 5 Repeat these steps for all light barriers you want to delete.

6.2.3 Teaching in the door supervision device



Prepare for magnet housing mounting as described in 4.3.3 Aligning the magnet and mounting the magnet housing, [EN-38](#).

The adhesive strip for affixing the magnet housing cannot be removed once it has been adhered. That is why a second person is needed to align the magnet so it is in the correct position and affix it once the magnet has been detected and displayed in the software.

The following steps are necessary for teaching in the door supervision device:

- ▶ Teach in the door supervision device into the system with EmoTouch 3, [EN-65](#)
- ▶ Teach in the RFID tag with EmoTouch 3, [EN-68](#)

▶ Teach in the door supervision device into the system with EmoTouch 3

- 1 Press  for 3 seconds.
- 2 Enter code **9851** and confirm with .

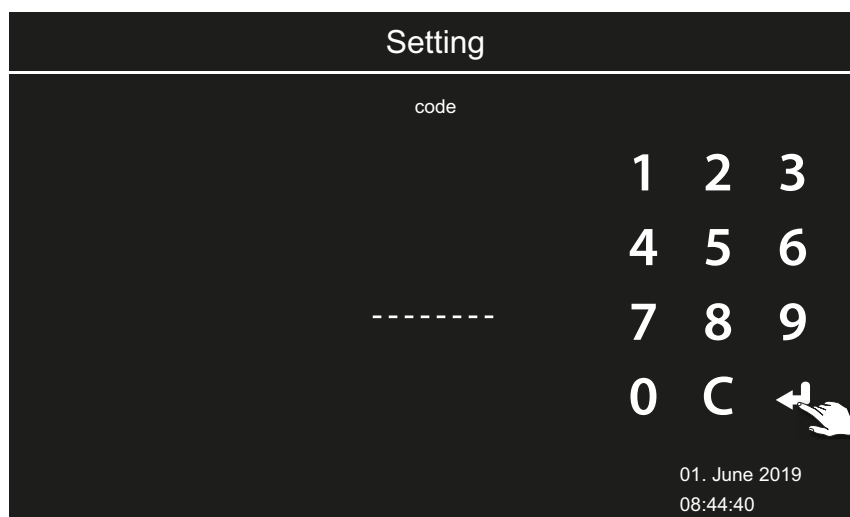

Commissioning

3 Tap the programming button **C**.

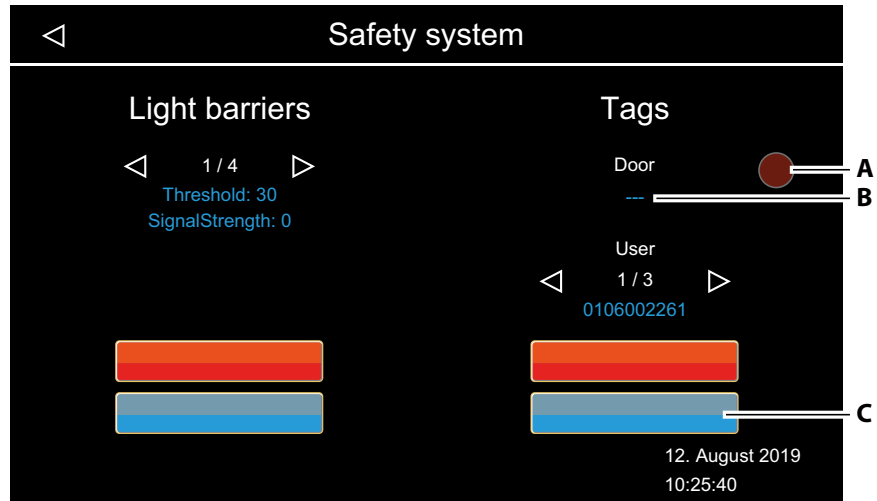

A Start-up status control light

B Magnet value

C Start and complete teach-in mode

- ① The control light **A** is light red if the cabin is safety compliant and dark red if the cabin is not safety compliant.
 - ① The door supervision device switches to teach-in mode.
 - ① The magnet value is displayed in the menu only if the door supervision device is in teach-in mode or if at least one RFID tag has been taught in.
- 4** Close the cabin door and hold the magnet housing in the position intended for affixing.
- ① The area where the strips will be applied must be free of dust and grease.
 - ① The adhesive strip for affixing the magnet housing cannot be removed once it has been adhered. That is why a second person is needed to align the magnet so it is in the correct position and then affix the magnet housing once the software displays that the magnet has been detected in its selected position.
 - ① Ensure that it is aligned properly: The narrow side of the magnet housing must face upward.
 - ① Teach-in mode is displayed by the red LED on the door supervision device when the magnet is detected. This helps with general alignment.

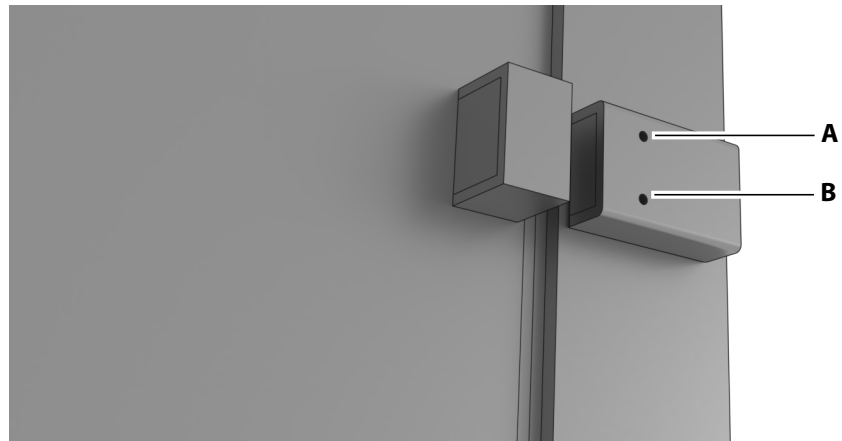

A Green LED

B Red LED

- 5** Check in the display if the value **B** of the magnet is displayed in the *Sicherheitseinrichtung* [Safety device] dialogue box.
 - ① The value must lie between 10 and 30 or between 70 and 90, ideally it is close to 20 or 80.
 - ① You can affix the magnet housing once the value lies within the specified value range.
If the value lies outside of the specified range, you must realign the position of the magnet. See
4.3.3 Aligning the magnet and mounting the magnet housing, 
EN-38
- 6** Loosen the protective film from the adhesive strip on the back of the magnet housing.
- 7** Firmly adhere the magnet housing to the identified position on the door panel and firmly press down on the housing.
 - ① The adhesive strip has fully bonded after 72 hours.
- 8** Tap **D** to exit teach-in mode.

Commissioning

► Teach in the RFID tag with EmoTouch 3

- 1 Open the cabin door.
- 2 Tap the programming button **D**.

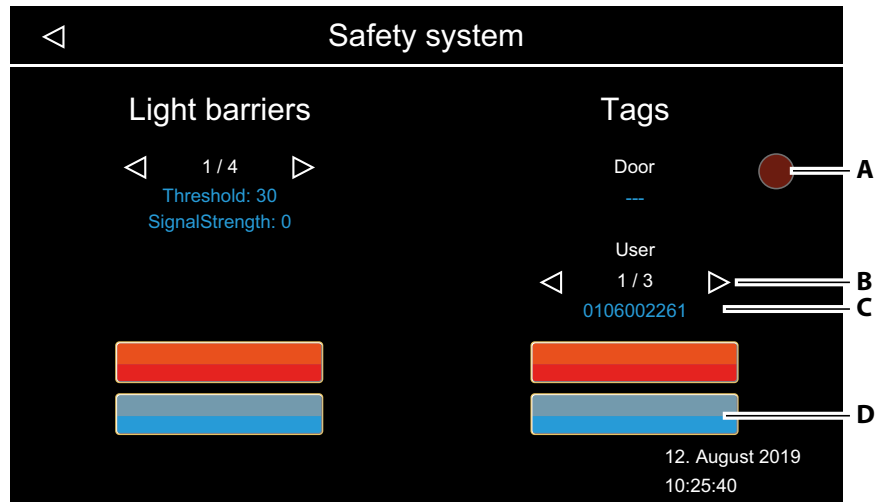

- A** Start-up status **B** Select user
C Tag ID **D** Start and complete teach-in mode

- ⓘ The control light **A** is light red if the cabin is safety compliant and dark red if the cabin is not safety compliant.
- ⓘ The door supervision device switches to teach-in mode.

- 3 Hold the RFID tag up to the narrow front side of the door supervision device that faces the magnet housing.
 - ⓘ The maximum distance of the RFID tag to the door supervision device is 1 cm.

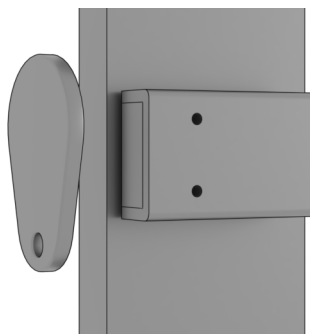



- ⓘ The RFID tag is created as a user (**B**) in the system and the ID is displayed (**C**).

- 4 Repeat step **3** for all other RFID tags.
- 5 Tap **D** to exit teach-in mode.
 - ⓘ The RFID tags have been taught in.

6.2.4 Deleting RFID tags

► Delete RFID tags with EmoTouch 3

- 1 Press  for 3 seconds.
- 2 Enter code **9851** and confirm with .



- 3 Select the RFID tag you want to delete by choosing **A**.

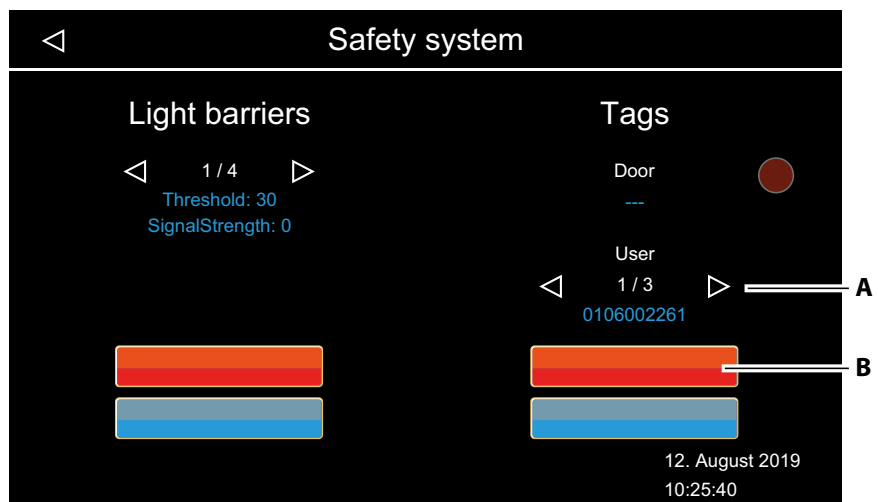

A Select user

B Delete RFID users

- 4 Tap the delete button **B**.
 ⓘ The RFID tag is deleted.

- 5 Repeat these steps for all of the RFID tags you want to delete.

6.3 Commissioning with EmoTec, EmoStyle, and Econ

The light barriers and/or the door supervision device must be taught in for commissioning.

6.3.1 Teaching in the light barriers

You will have to teach in all light barriers that are installed and plugged in to the circuit board. The safety circuit is interrupted if light barriers are connected but not taught in.

Teaching in must be done using the buttons on the circuit board of the EOSafe supervision unit for systems that use EmoTec, EmoStyle or Econ control panels.

The sauna heater may not be on when light barriers are taught in.

Once you have installed EOSafe L/D, a second person is needed in the cabin to realign the light barriers and teach them in because you cannot use EOSafe D to open the cabin without switching off the system.

► Teach in the light barriers with EmoTec, EmoStyle or Econ

- 1 Disconnect the EOSafe supervision unit from the mains supply.
- 2 Remove the housing cover. See ► Mount the supervision unit housing, [EN-28](#).
- 3 **DANGER!** The covered area of the circuit board is under live current. Do not remove the cover plate.
Plug in the supervision unit to the mains supply.

- 4** Press the programming button **C** for the light barrier you want to teach in for approx. 10 seconds.

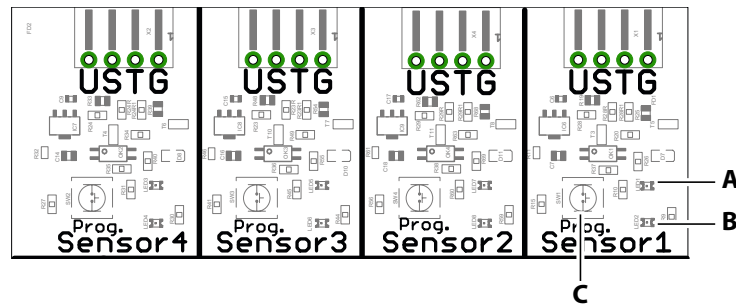

- A** Red LED **B** Green LED **C** Programming button
-  Example: Light barrier 1

- ① Programming mode is activated.

The programming LED **A** flashes red periodically.

The programming LED **B** flashes green depending on the signal value.

The light barrier is switched on and generates a permanent point of light.

- 5** Align the point of light in the cabin (as needed) with the 3 adjusting screws so it shines directly on the reflector.

See ► Readjust during commissioning,  EN-35.

- ① The highest possible signal value is needed for smooth operation.
The better the signal value, the longer the LED is green.

- 6** Repeat step **5** until an optimal signal value is achieved.

The light barrier has been taught in as soon as fine alignment and updating of the signal value are complete.

- ① Remember to place the front ring with the protective disk back in place at the taught-in light barrier in the cabin and tighten it with the set screws.

- 7** Press the programming button **C** for the light barrier for approx. 2 seconds.

① The signal value of the light barrier is saved.

① The programming LED **B** is green.

① The control panel is activated.

Commissioning

- 8 Repeat these steps for all connected light barriers.
- 9 Close the housing of the EOSafe L/D supervision unit.

6.3.2 Deleting light barriers

► Delete light barriers with EmoTec, EmoStyle or Econ

- 1 Disconnect the EOSafe supervision unit from the mains supply.
- 2 Remove the housing cover. See ► Mount the supervision unit housing, EN-28.
- 3 **DANGER!** The covered area of the circuit board is under live current. Do not remove the cover plate.
Plug in the supervision unit to the mains supply.
- 4 Press the programming button **C** for the light barrier you want to delete for approx. 30 seconds.

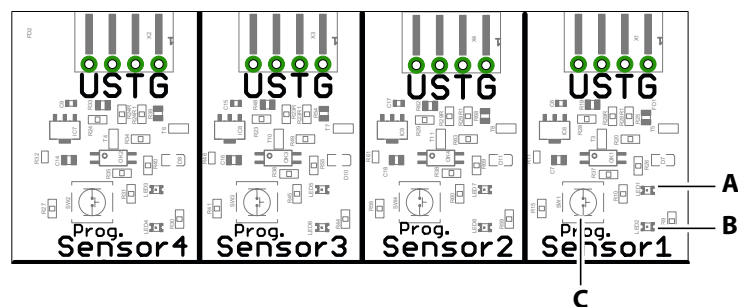

A Red LED

B Green LED

C Programming button

☒ Example: Light barrier 1

ⓘ If both programming LEDs flash alternately in the same interval, the taught-in values have been deleted. Subsequently, the green LED **B** goes off and the red LED **A** illuminates.

☑ Repeat the teaching in of the light barrier. See ► Teach in the light barriers with EmoTec, EmoStyle or Econ, EN-70.
Fine adjustments in the cabin may no longer be necessary.

- 5 Close the housing of the EOSafe L/D supervision unit.

6.3.3 Teaching in the door supervision device

Prepare for magnet housing mounting as described in 4.3.3 Aligning the magnet and mounting the magnet housing, [EN-38](#).

The adhesive strip for affixing the magnet housing cannot be removed once it has been adhered. That is why a second person is needed to align the magnet so it is in the correct position and then affix the magnet housing once the software displays that the magnet has been detected in its selected position.

The following steps are necessary for teaching in the door supervision device:

▶ Teach in the door supervision device with EmoTec, EmoStyle or Econ, [EN-73](#)

▶ Teach in the RFID tag with EmoTec, EmoStyle or Econ, [EN-75](#)

▶ **Teach in the door supervision device with EmoTec, EmoStyle or Econ**

- 1 Disconnect the EOSafe supervision unit from the mains supply.
- 2 Remove the housing cover. See ▶ Mount the supervision unit housing, [EN-28](#).
- 3 **DANGER!** The covered area of the circuit board is under live current. Do not remove the cover plate.
Plug in the supervision unit to the mains supply.

Commissioning

- 4 Press the programming button **C** for approx. 10 seconds.

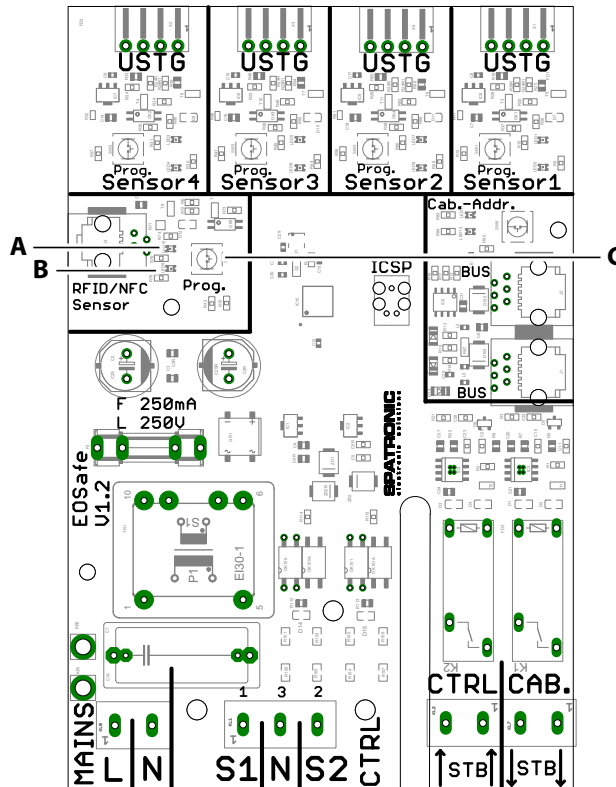

- A** Programming LED – green **B** Programming LED – red
C Programming button

① Programming mode is activated.

The green programming LED **A** lights up.

The red programming LED **B** flashes.

- 5 Close the cabin door and hold the magnet housing in the position intended for affixing.

① The area where the strips will be applied must be free of dust and grease.

① Ensure that it is aligned properly: The narrow side of the magnet housing must face upward.

① Teach-in mode is displayed by the red LED **B** on the door supervision device when the magnet is detected. This helps with general alignment.

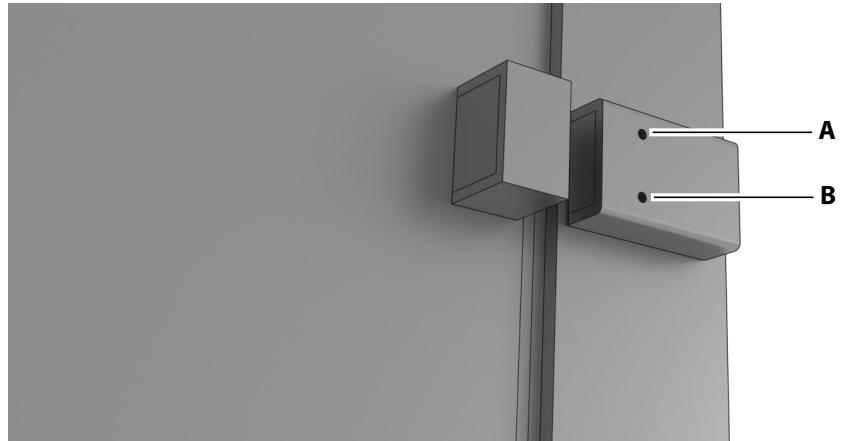

A Green LED

B Red LED

- 6** Move the magnet housing up, down, right and left to determine the limits of the detection zone.
 - ① It takes about 5 seconds for the LEDs to update.
 - ① If the red LED **B** on the housing of the door supervision device is illuminated, the magnet has been detected.
- 7** Loosen the protective film from the adhesive strip on the back of the magnet housing.
- 8** Firmly adhere the magnet housing in the centre of the detection zone on the door panel and firmly press down on the housing.
 - ① The area where the strips will be applied must be free of dust and grease.
 - ① The adhesive strip has fully bonded after 72 hours.
- 9** Press the programming button for approx. 2 seconds to end teach-in mode.

► **Teach in the RFID tag with EmoTec, EmoStyle or Econ**

- 1** Open the cabin door.
- 2** Press the programming button **C** for approx. 10 seconds.

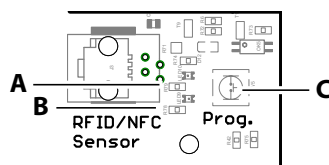

A Programming LED – green

B Programming LED – red

C Programming button

- ① Programming mode is activated.

Commissioning

- 3** Open the door and hold the RFID tag up to the narrow front side of the door supervision device that faces the magnet housing.
 - ① The maximum distance of the RFID tag to the door supervision device is 1 cm.

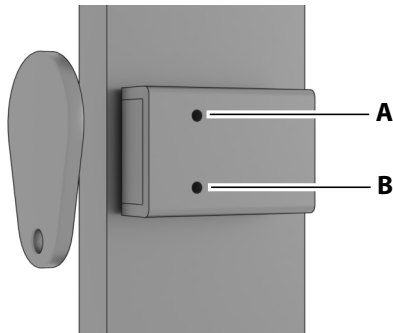

A Green LED

B Red LED

- ① The green LED **A** on the housing of the door supervision device flashes if the RFID tag has been detected.
- 4** Repeat step **3** for all other RFID tags.
- 5** Press the programming button **C** for approx. 2 seconds to end teach-in mode.
 - ① The RFID tag has been taught in.
- 6** Close the housing of the EOSafe L/D supervision unit.

6.3.4 Deleting an RFID tag

During installation, the RFID tag values may only be reset together with EmoTec, EmoStyle or Econ control panels. Once this is done, you must teach in the RFID tags you need again.

► Delete RFID tags with EmoTec, EmoStyle or Econ

- 1 Disconnect the EOSafe supervision unit from the mains supply.
- 2 Remove the housing cover. See ► Mount the supervision unit housing, EN-28.
- 3 **DANGER!** The covered area of the circuit board is under live current. Do not remove the cover plate.
Plug in the supervision unit to the mains supply.
- 4 Press the programming button **C** for approx. 30 seconds.

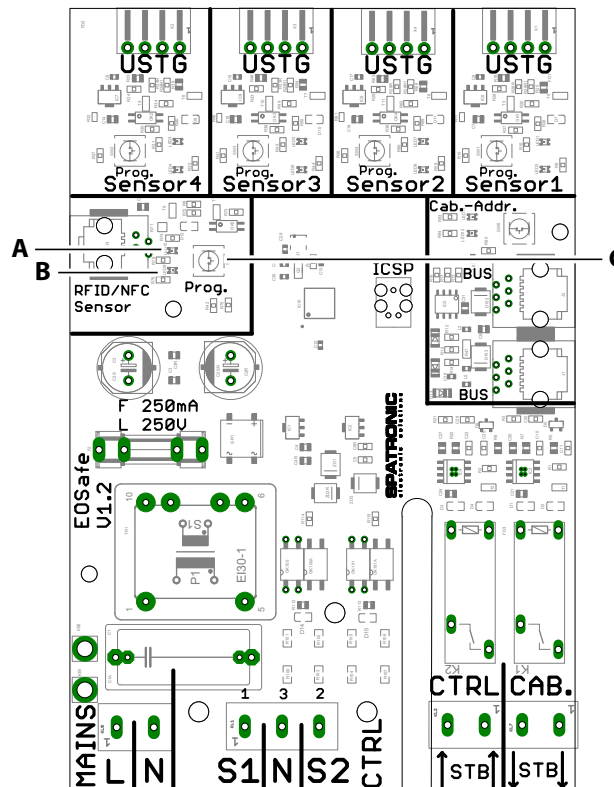

- A** Programming LED – green **B** Programming LED – red
C Programming button

① All RFID tags have been deleted once LEDs **A** and **B** flash alternately in the same interval.

- 5 Teach in all required RFID tags again.
 - ① See ► Teach in the RFID tag with EmoTec, EmoStyle or Econ, EN-75

6.4 Confirming with RFID tags that the cabin is safety compliant

If the door supervision device has been installed, the cabin can be switched on only if it has been confirmed as safety compliant. To perform commissioning checks, the cabin must be confirmed as safety compliant by the RFID tag if both the light barriers and the door supervision device are installed.

► Confirm that the cabin is safety compliant

- 1 Open the cabin door.
- 2 Ensure that no objects are covering the heater.
- 3 Hold the RFID tag up to the door supervision device.
 - ① The green LED **A** on the housing of the door supervision device flashes if the RFID tag has been detected.
- 4 Close the cabin door within the next 30 seconds.
 - ① For the light barrier test, you must remain in the cabin and keep the door closed for the next 10 minutes. See ► Check the light barrier in the cabin, □ EN-88

6.5 Commissioning checks

You must perform a check once EOSafe is installed, connected and set up.

You must check the following:

- ▶ Check the safety circuit at the supervision unit, [EN-80](#)
- ▶ Check signal S1/S2, [EN-85](#)
- ▶ Check the cabin door supervision device, [EN-87](#)
- ▶ Check the light barrier in the cabin, [EN-88](#)
- ▶ Confirm the installation check, [EN-89](#)

EOSafe must reliably detect and signal any simulated malfunctions. See also chapter 7.3 Flashing codes, [EN-91](#)



⚠ WARNING

Danger to life and limb

Electrical currents pose a danger to life and limb. The system may not be disconnected from the mains supply for the duration of the checks.

- ▶ Only trained personnel may perform the commissioning checks.

6.5.1 Safety circuit – EOSafe L/D, EOSafe L, EOSafe D

This test is intended to verify if the safety temperature limiter is properly installed.

Check requirements:

- The EOSafe supervision unit and sauna relay box are switched on.
- The sauna heater is switched off.
- Installation with light barrier:
The light barrier's light beam is not interrupted.
- Installation with door supervision device:
The cabin was checked and confirmed as safety compliant with an RFID tag.
- The notifications *Thermal fuse triggered* or *Safety circuit* are not displayed on the control panel.

The following checks should be performed for the safety circuit:

- ▶ Check the safety circuit at the safety temperature limiter, [EN-80](#)
- ▶ Check the safety circuit at the supervision unit, [EN-80](#)

Commissioning

Maintaining and confirming the items on the checklists is mandatory for the commissioning checks. Complete the separate checklists while performing commissioning checks and then confirm in the checklists and under ► Confirm the installation check, ☐ EN-89 that these checks have been properly performed.

► Check the safety circuit at the safety temperature limiter

- 1 In the cabin, disconnect one of the white cables **1** or **2** at the safety temperature limiter in the temperature sensor housing.

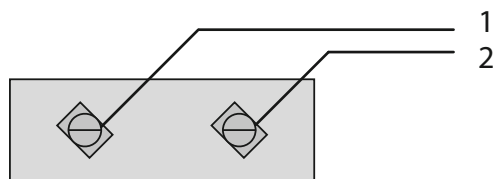

- a) The message *Thermal fuse triggered* or *Safety circuit* is displayed on the control panel.
 - b) The message is not displayed because there is a short circuit. Check the setup and cables of the units and remedy any issues. Repeat the entire installation test once you have corrected the problem.
- 2 Reconnect the cables to the safety temperature limiter in the cabin.
 - ☑ The message *Thermal fuse triggered* or *Safety circuit* is no longer displayed on the control panel.

► Check the safety circuit at the supervision unit

- 1 **DANGER!** The covered parts of the circuit board are under live current. Do not remove the cover plate. Remove the housing cover of the EOSafe supervision unit. See ► Mount the supervision unit housing, ☐ EN-28.

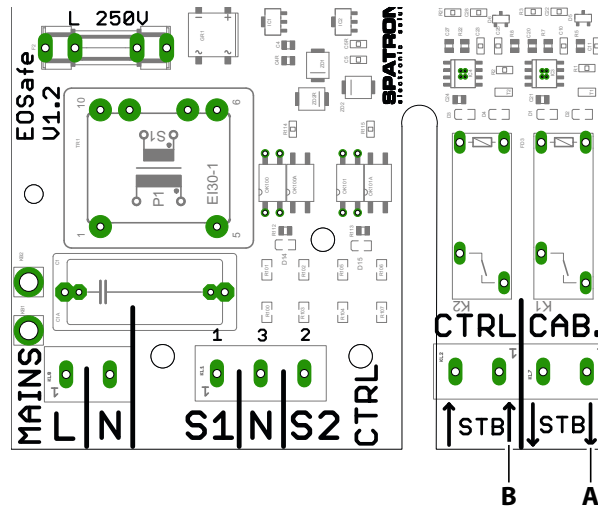

- A** Cable from EOSafe supervision unit to safety temperature limiter in the cabin
- B** Cable from EOSafe supervision unit to relay box

- 2 Disconnect the connection *Safety circuit, input from relay box (B)*.
 - ① You do not have to disconnect both of the cables. One will suffice.
 - a)** One of the messages *Thermal fuse triggered* or *Safety circuit* is displayed on the control panel. Installation is OK.
 - b)** No message is displayed on the control panel. Installation is not OK. Check the installation and remedy the issue. Repeat the entire installation test once you have corrected the problem.
- 3 Reconnect the cable.
 - No message is displayed on the control panel.
- 4 Disconnect the connection *Safety circuit, output to safety temperature limiter (A)*.
 - ① You do not have to disconnect both of the cables. One will suffice.
 - a)** One of the messages *Thermal fuse triggered* or *Safety circuit* is displayed on the control panel. Installation is OK.
 - b)** No message is displayed on the control panel. Installation is not OK. Check the installation and remedy the issue. Repeat the entire installation test once you have corrected the problem.
- 5 Reconnect the cable.
 - ① No message is displayed on the control panel.
 - The commissioning check for the safety temperature limiter has been completed successfully.

6.5.2 3-phase installation – EOSafe L/D, EOSafe L

This test is required for the installation of EOSafe with light barriers. To perform the test, disconnect the neutral conductor at the relay box. You must also open the housing for the corresponding relay box for this test.

Test requirements:

- Installation with door supervision device:
The cabin is confirmed as safety compliant with an RFID tag. There is a second person in the cabin who interrupts the light beam for the check.
- There is no error message for the safety temperature limiter displayed on the control panel.

Maintaining and confirming the items on the checklists is mandatory for the commissioning checks. Complete the separate checklists while performing commissioning checks and then confirm in the checklists and under ► Confirm the installation check, □ EN-89 that these checks have been properly performed.

► Check 3-phase installation of the sauna control

- 1 Switch off the EOSafe supervision unit and the sauna relay box and completely disconnect both from the mains supply.
- 2 Remove the housing cover from the sauna relay box.
- 3 **DANGER!** The circuit board may still have an electrical current even if it has been switched off. The test should be performed only by trained personnel.
Disconnect the neutral conductor at the sauna relay box.
① The terminal is either **C** or **Cc**, depending on the installation.

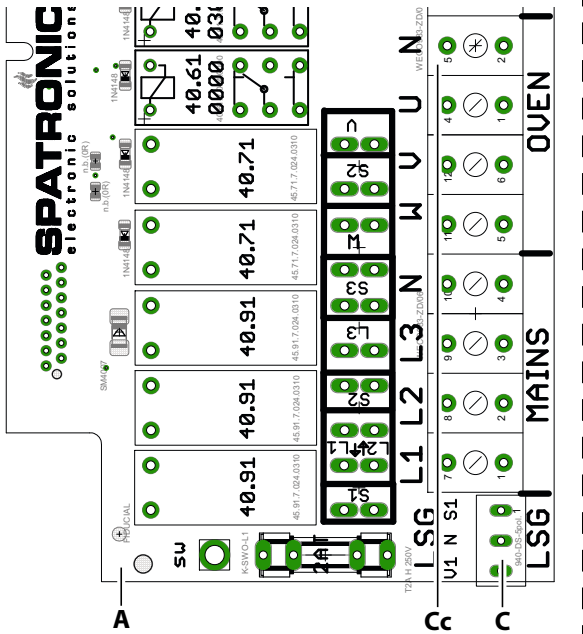

A Econ relay box
C Connection for neutral conductor

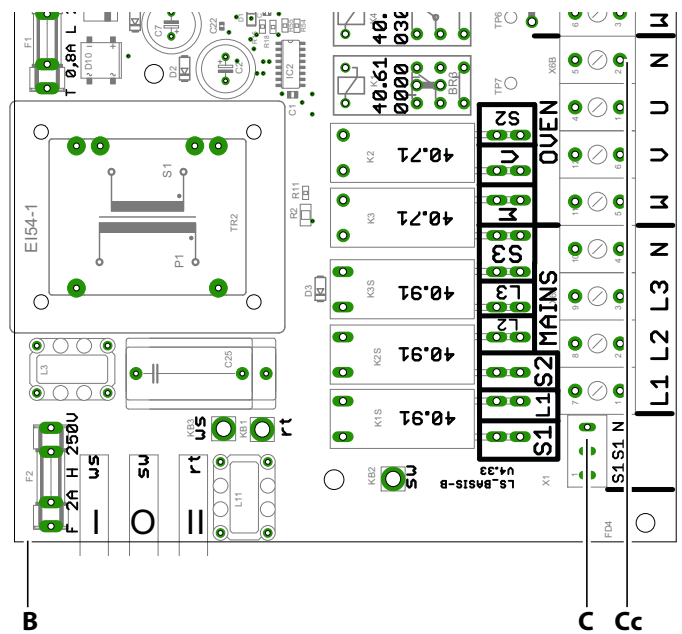

B EmoTec relay box
Cc Alternative connection for neutral conductor

- 4 Reconnect the EOSafe supervision unit and the sauna relay box to the mains supply and switch them both on.
 - a) EOSafe with door supervision device:
 A second person has checked the heater, confirmed the cabin as safety compliant with the RFID tag and has remained in the cabin after it has been switched on to check the light barriers.
 - 5 Switch on the heater at the control panel.
 - 6 Interrupt the light barrier's light beam.
 - a) The light barrier flashes every 10 seconds despite the fact that the neutral conductor has been interrupted. One of the messages *Thermal fuse triggered* or *Safety circuit* is displayed on the control panel after the light beam has been interrupted. Installation is OK.
 - b) No message is displayed on the control panel. Installation is not OK. Check the installation and remedy the issue. Repeat the entire installation test once you have corrected the problem.
- ① The installation must be a 3-phase installation, otherwise when the neutral conductor is interrupted, EOSafe L cannot determine if the sauna relay box was switched on or off.

Commissioning

- 7 Disconnect the EOSafe supervision unit and the sauna relay box from the mains supply again.
- 8 Reconnect the neutral conductor to the sauna relay box.
- 9 Reconnect the EOSafe supervision unit and the sauna relay box to the mains supply and switch them both on.
 - a) EOSafe with door supervision device:
A second person has checked the heater, confirmed the cabin as safety compliant with the RFID tag and has remained in the cabin after it has been switched on to check the light barriers.
- 10 Interrupt the light barrier's light beam.
 - ① A message is displayed on the control panel.
 - The commissioning check for the 3-phase installation of the sauna control has been completed successfully.

6.5.3 Signal S1/S2 (start-up status) – EOSafe L/D, EOSafe L, EOSafe D

This test ensures that the supervision unit identifies the error condition. The cabin may not be switched on. Installations with light barriers require that the test for 3-phase installation is successfully completed prior to this test. See ► Check 3-phase installation of the sauna control, □ EN-82.

Test requirements:

- The test for 3-phase installation of the light barrier has been completed successfully.
- Installation with door supervision device:
The cabin is confirmed as safety compliant with an RFID tag. There is a second person in the cabin who interrupts the light beam for the check.
- The control panel does not display an error message for the start-up status.

For this test, you must open the housing for the sauna relay box. Maintaining and confirming the items on the checklists is mandatory for the commissioning checks. Complete the separate checklists while performing commissioning checks and then confirm in the checklists and under ► Confirm the installation check, □ EN-89 that these checks have been properly performed.

► **Check signal S1/S2**

- 1 Switch off the EOSafe supervision unit and the sauna relay box and completely disconnect both (all poles) from the mains supply.
- 2 Remove the housing cover from the sauna relay box.
- 3 **DANGER!** The circuit board may still have an electrical current even if it has been switched off. The test should be performed only by trained personnel.

At the sauna relay box, disconnect the flat plug **C** at the S2 connection for the start-up status signal.

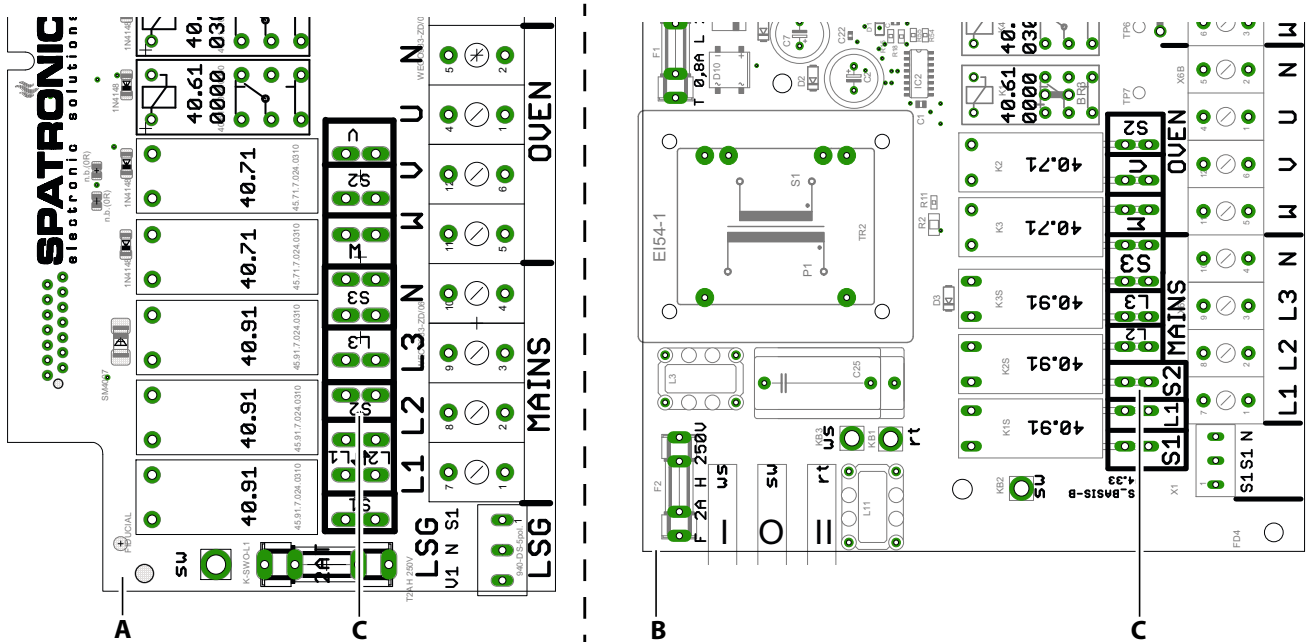

A Econ relay box
C Flat pin S2

B EmoTec relay box
C Flat pin S2

- 4 Reconnect the EOSafe supervision unit and the sauna relay box to the mains supply and switch them both on.
 - a) EOSafe with light barrier:
The light barriers' light beam is not interrupted.
 - b) EOSafe with door supervision device:
The heater has been checked. The cabin is confirmed as safety compliant with an RFID tag.
- ① No error message is displayed on the control panel.

Commissioning

- 5 Switch on the heater at the control panel.
 - a) An error message is displayed on the control panel.
The red status LED issues flashing code 2 on the supervision unit. See chapter 7.3 Flashing codes, [EN-91](#).
The control unit switches off the heater. Installation is OK.
 - b) No error message is displayed on the control panel.
The control unit does not switch off the heater. Installation is not OK.
Check the installation and remedy the issue.
Repeat the entire installation test once you have corrected the problem.
- 6 Disconnect the EOSafe supervision unit and the sauna relay box (all poles) from the mains supply again.
- 7 At the sauna relay box, reconnect the flat plug **C** at the S2 connection.
- 8 Reconnect the EOSafe supervision unit and the sauna relay box to the mains supply and switch them both on.
 - a) EOSafe with light barrier:
The light barriers' light beam is not interrupted.
 - b) EOSafe with door supervision device:
The heater has been checked. The cabin is confirmed as safety compliant with an RFID tag.
- 9 Switch on the heater at the control panel.
 - ① No message is displayed on the control panel.
EOSafe does not display a flashing code for errors.
 - The commissioning check for signal S1/S2 has been completed successfully.

6.5.4 Door supervision device – EOSafe L/D, EOSafe D

This test checks the installation of the door supervision device.

Test requirements:

- The EOSafe supervision unit and sauna relay box are switched on.
- The sauna heater is switched off.
- The cabin is confirmed as safety compliant with an RFID tag.
- Installation with door supervision device:
The light barrier's light beam is not interrupted.
- There is no error message for the safety circuit displayed on the control panel.

Maintaining and confirming the items on the checklists is mandatory for the commissioning checks. Complete the separate checklists while performing commissioning checks and then confirm in the checklists and under ► Confirm the installation check, EN-89 that these checks have been properly performed.

► Check the cabin door supervision device

- 1 Switch on the heater at the control panel.
- 2 Open the sauna door during the heat-up phase, i.e. within the next 10 minutes.
 - a) The heater is switched off.
An error message for the safety circuit is displayed on the control panel. Installation is OK.
 - b) There is no error message for the safety circuit displayed on the control panel. Installation is not OK. Check the installation and remedy the issue.
Repeat the entire installation test once you have corrected the problem.
- 3 Ensure that the system is prepared for the check and switch on the heater at the control panel.
 - ① No message is displayed on the control panel.
- 4 Open the sauna door after the heat-up phase, i.e. after at least 11 minutes have elapsed.
 - ① There is no error message for the safety circuit displayed on the control panel.
 - The commissioning check for the door supervision device has been completed successfully.

6.5.5 Light barrier – EOSafe L/D, EOSafe L

This test checks if the light barriers function properly.

Test requirements:

- The EOSafe supervision unit and sauna relay box are switched on.
- The light barrier's light beam is not interrupted.
- Installation with door supervision device:
The cabin is confirmed as safety compliant with an RFID tag. There is a second person in the cabin who interrupts the light beam for the check.
- No error message for the safety circuit is displayed on the control panel.

Maintaining and confirming the items on the checklists is mandatory for the commissioning checks. Complete the separate checklists while performing commissioning checks and then confirm in the checklists and under ► Confirm the installation check, □ EN-89 that these checks have been properly performed.

► Check the light barrier in the cabin

- 1 Switch on the heater at the control panel.
 - ① If EOSafe L/D is also installed, the cabin must be confirmed as safety compliant and a second person must remain in the cabin to interrupt the light barriers' light beam.
- 2 Interrupt the light beam from the first light barrier with a non-transparent and non-flammable object.
 - a) On the EOSafe supervision unit, the red LED for light barrier 1 is lit. An error message for the safety circuit is displayed on the control panel. The control unit switches off the heater. The light barrier functions properly.
 - b) No messages for the safety circuit are displayed on the control panel. The control unit does not switch off the heater. Installation is not OK. Check the installation and remedy the issue. Repeat the entire installation test once you have corrected the problem.
- 3 Ensure that the system is prepared for the check and repeat the steps for each of the remaining light barriers.
 - ☑ The commissioning check is successfully completed once all light barriers function properly.

6.5.6 Confirming the installation check

Complete the separate checklists while performing commissioning checks and then confirm in the checklists and below that they have been properly performed. This is mandatory.

► Confirm the installation check

- 1 Complete the checklist below and confirm that the installation check has been completed by signing and dating.

Installation check			
The commissioning check for the safety circuit is complete.	The commissioning check for signal S1/S2 is complete.	The commissioning check for the door supervision device is complete.	The commissioning check for the light barriers is complete.
Date and signature	Date and signature	Date and signature	Date and signature

7

Cleaning and troubleshooting

EOSafe L must be cleaned regularly. The cleaning frequency depends on how often it is used. Because the light barriers are installed and operated above the sauna heater, contamination is possible and the light barriers may move, which could impact proper functioning.

7.1 Checking and possibly cleaning all light barrier front panels and reflectors

The recommended frequency for checks and cleaning is once per week; it may be more often, depending on how much it is used.

⚠ CAUTION

Risk of burns

The sauna heater can be very hot.

- ▶ Begin service work only once the steam generator has been switched off and is cool.

NOTICE

Equipment damage

The glass reflectors of EOSafe L can shatter if temperatures fluctuate quickly.

- ▶ Do not pour infusion liquid on the reflectors.

► **Check and possibly clean all light barrier front panels and reflectors**

- 1 CAUTION! Ensure that the mains connection for the supervision unit is disconnected.
Allow the sauna heater to cool for approx. 30-45 minutes. Wear gloves.
- 2 Check the front disks of all light barriers and all reflectors for contamination and deposits.
- 3 Clean contaminated components with a soft cloth and a commercial cleaner.
 - ☑ Checking and cleaning is now complete.

7.2 Readjusting the light barriers

The light barriers may move when the sauna cabin wood expands and contracts. In this case, the proper functioning of EOSafe L can no longer be guaranteed. See ► Readjust during commissioning, 📄 EN-35.

7.3 Flashing codes

The tables below show the flashing codes for the light barriers and door supervision device.

Flashing code for status			
	Red LED:		Green LED:
Setup:	2 Hz periods		Cabin address
Pressing and holding the key:	Alternating 2 Hz periods		Alternating 2 Hz periods
Normal operation:	Off		2 Hz periods
Error messages:	Number:	Error:	Off
	2	S1/S2 (broken cable, improper mounting)	
	3	Light barrier (flashing code, observe light barrier)	
	4	Door supervision device (flashing code, observe door supervision device)	
	5-20	EOSafe electronic malfunction	

Cleaning and troubleshooting

Flashing code for light barrier			
	Red LED:		Green LED:
Setup:	2 Hz periods		Lighting duration = signal strength (lower value: short flash, higher value: is lit)
Not set up:	On		Off
Pressing and holding the key:	Alternating 2 Hz periods		Alternating 2 Hz periods
Normal operation:	Set up/no error: Off; Object detected: On		Light barrier off: is lit; light barrier on: flashes in 10-second intervals
Error messages:	Number:	Error:	Off
	3/5	Electronic malfunction (3 = EOSafe, 5 = light barrier)	
	4	Communication (broken cable, light barrier defective)	
	6	Not set up	

Flashing code for door supervision device			
	Red LED:		Green LED:
Setup:	Magnet detected: is lit		RFID tag detected: flashes
Not set up:	On		Off
Pressing and holding the key:	Alternating 2 Hz periods		Alternating 2 Hz periods
Normal operation:	Set up/no error: Off; RFID tag not taught in/OK: flashes		Set up: is lit; RFID tag detected: flashes
Remote control activated:	On		On
Error messages:	Number:	Error:	Off
	3/5	Electronic malfunction (3 = EOSafe, 5 = door supervision device)	
	4	Communication (broken cable, door supervision device defective)	
	6	Door supervision device (magnetic strength outside of valid ranges)	

7.4 Troubleshooting

Error	Reason	Solution
Light beam no longer hits the reflector or is no longer received in the ceiling unit	Ceiling unit is not level.	Adjust the light beam. Install a new ceiling unit if necessary.
	Light beam is not aligned.	Wood expands and contracts and therefore impacts adjustments made. Readjust the light beam.
	Heater moved.	Move heater into the correct location. Readjust the light beam. If necessary, secure the heater so it cannot be moved.
	Glass pane in the ceiling unit is contaminated or damaged.	Remove the front ring and clean the glass pane. Replace the glass pane if necessary.
	Reflector is dirty or damaged.	Clean the reflector or replace it if necessary. Do not pour infusion over the reflector.
Light beam is not detected.	Light barrier is taught in incorrectly.	EmoTouch 3 only: Set light barrier to maximum threshold.
Light barrier does not function properly	Cable is not routed in accordance with the installation instructions.	Cable length: max. 5 m A cable extension may not be used. Do not route the cable together with live lines.
		Safety temperature limiter was triggered in the sensor housing.
Door supervision device does not function properly	Cable is not routed in accordance with the installation instructions.	Cable length: max. 5 m A cable extension may not be used. Do not route the cable together with live lines.
		Position of the magnet housing in relation to the door supervision device housing has changed.
	Safety temperature limiter was triggered in the sensor housing.	Troubleshoot the cause of the trigger and replace the safety temperature limiter in the sensor housing.

8

General terms and conditions of service

(T&C, Dated 08-2018)

I. Scope

Unless otherwise agreed in writing for specific instances, these terms and conditions of service shall apply to service operations, including reviewing and remedying complaints. All our existing or future legal relationships shall be governed solely by the following terms and conditions of service. We do not recognise any of the customer's conflicting terms and conditions unless we have given our express written consent to their applicability.

We hereby expressly object to any of the customer's terms and conditions included in the customer's General Terms and Conditions of Business or order confirmation. Unconditional acceptance of order acknowledgments or deliveries shall not be construed as any form of acknowledgment of such terms and conditions. Ancillary agreements or amendments must be confirmed in writing.

II. Costs

The customer shall bear the following costs in connection with services rendered:

- Mounting/dismantling and electrical (de-)installation
- Transportation, postage and packaging
- Function testing and troubleshooting, including inspection and repair costs

There shall be no third-party billing.

III. Performance and cooperation obligations

The customer shall provide assistance free of charge to the manufacturer in rendering services.

In the case of a warranty claim, the manufacturer shall provide replacement parts necessary for servicing free of charge.

IV. Service visit by the manufacturer

Services rendered on site by an employee of the manufacturer must be agreed in advance.

If the main reason for the service visit is not the fault of the manufacturer, any costs incurred shall be charged to the customer after the service visit and must be paid by the customer in full within the agreed payment term.

V. Liability

The manufacturer shall assume liability in accordance with the currently applicable statutory regulations. All our products are packaged in such a way that the individually packed goods (pallets) can be shipped.

We wish to point out that our packaging is not suitable for individual shipments via parcel post. The manufacturer shall accept no liability for damages incurred as a result of improper packaging in an individual shipment.

VI. Manufacturer's warranty

The manufacturer's warranty shall apply only if installation, operation and maintenance have been carried out in full accordance with the manufacturer's specifications in the installation and operating instructions.

- The warranty period shall commence from the date on which proof of purchase is provided and shall be limited, in all cases, to 24 months.
- Warranty services shall be performed only if proof of purchase of the equipment can be presented.
- Any and all warranty claims shall become void if modifications are made to the equipment without the manufacturer's express consent.
- Any warranty claim shall likewise become void in the case of defects that arise due to repairs or interventions made by unauthorised persons or due to improper use.
- In the case of warranty claims, the serial and article numbers must be provided, together with the unit designation and a meaningful description of the error.
- This warranty shall cover defective equipment parts, with the exception of normal wear parts. Wear parts shall include, for example, light sources, glass elements, tubular heating elements and sauna heater stones.
- Only original replacement parts may be used within the warranty period.
- Service visits made by third parties shall require a written order issued by our service department.
- The equipment in question shall be sent to our service department by the customer at the customer's own expense.
- Electrical assembly and installation work, including service visits and parts replacements, shall be carried out at the customer's expense; costs shall not be borne by the manufacturer.

General terms and conditions of service

Complaints in respect of our products shall be reported to the responsible distributor and shall be handled exclusively by said distributor. The manufacturer's General Terms and Conditions of Business, in the version available at www.eos-sauna.com/agb, shall apply in addition to the foregoing terms and conditions of service.

9

Disposal

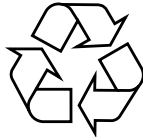

Electrical devices that are no longer needed must be recycled at a recycling station as per EU guideline 2012/19/EU or as per the Electrical and Electronic Equipment Act (ElektroG). Observe local provisions, laws, regulations, standards and directives when disposing of the unit.



Do not dispose of the unit with household waste.

Packaging

The packaging of the EOSafe L/D can be completely separated for disposal and recycled. The following materials are used in the packaging:

- Used paper/cardboard
- Plastic foil

Electronic waste

Electronic waste must be disposed of at the designated local collection point for electronic waste.

Declaration of conformity

10

Declaration of conformity

The EOSafe L/D supervision unit was tested in accordance with the Directives of the European Council on the Harmonisation of the Laws of the Member States relating to Electromagnetic Compatibility (2014/30/EU) and the Low Voltage Directive (2014/53/EU). Compliance was confirmed on 8 March 2019.

The complete report can be found on the EOS website: www.eos-sauna.com

EU-Konformitätserklärung EU-Declaration of Conformity



Für das folgend bezeichnete Erzeugnis
For the product designed as follows

Sicherheitseinrichtung für Saunaheizgeräte / Safety device for sauna heaters

Typ/Type: **EOSafe L/D**

wird hiermit bestätigt, dass es den wesentlichen Schutzanforderungen entspricht, die in der Richtlinie des Rates zur Angleichung der Rechtsvorschriften der Mitgliedstaaten über die elektromagnetische Verträglichkeit (2014/30/EU), der Niederspannungsrichtlinie (2014/35/EU) und Funkgeräterichtlinie (2014/53/EU) festgelegt sind.
Diese Erklärung gilt für alle Exemplare, die unter der angegebenen Artikelbezeichnung hergestellt werden. Alle Fertigungsunterlagen - die Bestandteil dieser Erklärung sind - werden ebenfalls unter der v.g. Artikelbezeichnung verwaltet.

We hereby certify that said product is in conformity with essential safety requirements specified in the Council Directive on the Approximation of the Laws of the Member States Relating to Electromagnetic Compatibility (2014/30/EU), the Low-Voltage Directive (2014/35/EU) and Radio Equipment Directive (2014/53/EU)

This declaration applies to all products manufactured under the article description listed. All manufacturing documents - which shall be regarded as part of this declaration - are also administered under the respective article description.

EN 61000-6-3:2007 + A1:2011

EN 301 489-1 V2.1.1

EN 300 330 V2.1.1

EN 61000-6-3:2007

EN 301 489-3 V1.6.1

EN 50364:2010

EN 60335-1:2012

EN 60335-2-53:2012

Diese Erklärung wird verantwortlich für den Hersteller/Importeur:
This declaration is submitted on behalf of the manufacturer/importer:

EOS Saunatechnik GmbH
Schneiderstriesch 1
35759 Driedorf, Germany

abgegeben durch / executed by

Rainer Kunz
(Name, Vorname / name, first name)

Geschäftsführende Gesellschafter / Managing Partner
(Stellung im Betrieb des Herstellers / Position in the manufacturing firm)

Driedorf
(Ort / place)

07.05.2019
(Datum / date)

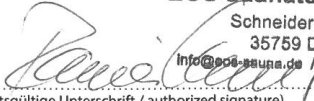
EOS Saunatechnik GmbH
Schneiderstriesch 1
35759 Driedorf
info@eos-sauna.de / www.eos-sauna.de

(Rechtsgültige Unterschrift / authorized signature)

Service address

EOS Saunatechnik GmbH
Schneiderstriesch 1
35759 Driedorf, Germany
Tel. +49 2775 82-0
Fax +49 2775 82-431
Mail servicecenter@eos-sauna.com
Web www.eos-sauna.com

Store this address with the Installation and Operating Instructions in a safe place.

Please always provide us with nameplate data, such as model, item number and serial number so we can provide fast and efficient support.

Date of sale

Stamp/retailer signature: